

# ALINCO

## HF ALL MODE TRANSCEIVER

# DX-77

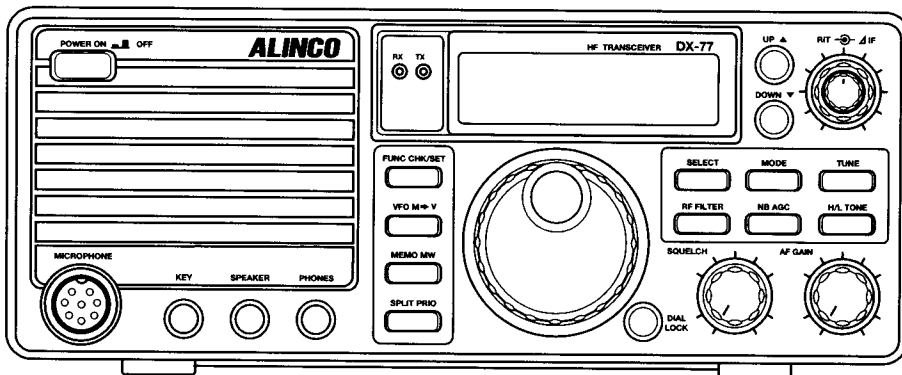

## Instruction Manual

Thank you for purchasing this **ALINCO** transceiver. To obtain optimum performance from this transceiver, read this instruction manual thoroughly, and keep it for future reference.

# CONTENTS

---

PRECAUTIONS	
HOW TO USE THIS MANUAL.....	iii
<b>Chapter 1 GETTING STARTED .....</b>	<b>1-1</b>
1.1 FEATURES .....	1-1
1.2 SUPPLIED ACCESSORIES .....	1-2
1.3 INSTALLATION AND CONNECTION (FOR BASE STATION).....	1-3
1.4 INSTALLATION AND CONNECTION (FOR MOBILE OPERATION) .....	1-6
1.5 CONTROLS, CONNECTORS, AND DISPLAY .....	1-8
Front Panel.....	1-8
Rear Panel Connectors .....	1-12
Microphone .....	1-13
Display .....	1-14
Controls Quick Reference .....	1-16
<b>Chapter 2 COMMUNICATIONS .....</b>	<b>2-1</b>
2.1 RECEPTION BASICS .....	2-1
2.2 TRANSMISSION BASICS .....	2-8
2.3 SSB OPERATION.....	2-10
2.4 PRACTICAL TECHNIQUES FOR SSB OPERATION.....	2-12
2.5 AM OPERATION .....	2-14
2.6 GENERAL COVERAGE RECEIVER OPERATION .....	2-15
2.7 FM OPERATION.....	2-16
2.8 REPEATER OPERATION.....	2-17
2.9 CW OPERATION .....	2-18
2.10 PRACTICAL TECHNIQUES FOR CW OPERATION .....	2-20
2.11 RTTY PACKET OPERATION.....	2-22
2.12 SPLIT-FREQUENCY OPERATION.....	2-23
<b>Chapter 3 MEMORY FEATURES.....</b>	<b>3-1</b>
3.1 BASICS .....	3-1
3.2 MEMORY MODE OPERATION .....	3-2
3.3 SIMPLEX-VFO-FREQUENCY PROGRAMMING .....	3-3
3.4 SIMPLEX-MEMORY-FREQUENCY PROGRAMMING .....	3-4
3.5 SPLIT-FREQUENCY PROGRAMMING (FOR GENERAL USE) .....	3-5
3.6 SPLIT-FREQUENCY PROGRAMMING (FOR REPEATER OPERATION).....	3-6
3.7 MEMORY CHANNEL DATA ERASING.....	3-8
3.8 MEMORY TO VFO DATA TRANSFER.....	3-9
<b>Chapter 4 SCANNING .....</b>	<b>4-1</b>
4.1 BASICS .....	4-1
4.2 BAND SCAN .....	4-4
4.3 MEMORY SCAN.....	4-5
4.4 PRIORITY SCAN .....	4-6

<b>Chapter 5 SPECIAL FEATURES .....</b>	<b>5-1</b>
5.1 INTERFERENCE REDUCERS .....	5-1
Introduction .....	5-1
IF SHIFT .....	5-1
Narrow Filter .....	5-2
CW BFO REVERSE .....	5-3
NB (Noise Blanker) .....	5-3
ATT (Attenuator) .....	5-3
5.2 OTHER USEFUL FUNCTIONS .....	5-4
RIT Function .....	5-4
VFO A=B .....	5-5
DIAL LOCK Function .....	5-6
<b>Chapter 6 SET-UP .....</b>	<b>6-1</b>
6.1 SET MODE .....	6-1
6.2 SET-UP ITEMS .....	6-3
Automatic USB/LSB Selection .....	6-3
Sidetone and CW Offset Setting .....	6-4
Break-in Delay Time .....	6-5
LCD Brightness .....	6-6
Beep .....	6-7
Speech Compressor .....	6-8
Transmission Inhibit .....	6-9
Frequency Step of the UP/DOWN Keys (SSB and CW Modes) .....	6-10
Frequency Step of the UP/DOWN Keys (AM mode) .....	6-11
Frequency Step of the UP/DOWN Keys (FM mode) .....	6-12
Memory Overwrite Protection .....	6-13
Memory Frequency Access Protection .....	6-14
SCAN Mode .....	6-15
Group Memory Scan .....	6-16
CTCSS Tone Setting .....	6-17
Electronic Keyer Setting .....	6-18
Cable Cloning .....	6-19
<b>Chapter 7 MAINTENANCE AND ADJUSTMENT .....</b>	<b>7-1</b>
7.1 ADJUSTMENT .....	7-1
Introduction .....	7-1
Adjustment Item List .....	7-1
Removing the Covers .....	7-1
Procedure .....	7-2
7.2 RESET .....	7-4
7.3 CLEANING .....	7-5
7.4 TROUBLESHOOTING .....	7-6
<b>APPENDICES</b>	
OPTIONS .....	Appendix-1
EXTERNAL ANTENNA TUNERS AVAILABLE .....	Appendix-2
INSTALLING THE OPTIONS .....	Appendix-4
SPECIFICATIONS .....	Appendix-5
INDEX .....	Appendix-7

# Chapter 1 Getting Started

## 1.1 FEATURES

---

### **DX-77 Features**

---

#### **HF band operation**

Covers HF (1.8 MHz to 28 MHz) amateur band in SSB, AM, FM, and CW modes.

#### **General coverage receiver**

Covers 500 kHz to 30 MHz in all modes.

#### **Front speaker**

Powerful and clear audio with 2 W Audio Amplifier.

#### **Front jacks**

Connecting easily with an external speaker, headphones, and a telegraph Key.

#### **Versatile interference eliminators**

The **IF SHIFT** function; Built-in audio filter as standard for CW; and RF attenuator, all effectively help to reject unwanted signals.

#### **Powerful CW operation**

Enables you to receive CW signals from either the upper or lower side of the carrier frequency. Selectable sidetone and pitch, **FULL BREAK-IN** (QSK), **SEMI BREAK-IN** (7 steps), and **AUTO BREAK-IN** (delay time automatically adjusted with keying speed). Optional electronic keyer.

#### **100 memory channels**

Each stores mode, filter, split frequencies, AGC, attenuator (or pre-amp) and noise-blanker settings.

#### **Computer control**

The DX-77 can be controlled by a personal computer through the serial interface. Settings of frequency, mode, power, and memory channel can be controlled.

## 1.2 SUPPLIED ACCESSORIES

---

### Checking Accessories

---

Check if these accessories are included in the shipping carton.

- DC power cable UA0052

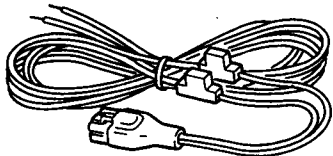

- Microphone EMS-42

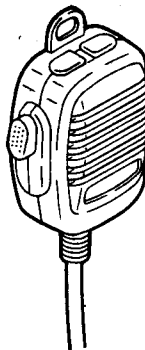

- Fuse

20A

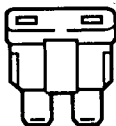

- Instruction manual (this manual)

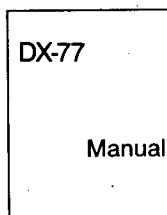

## 1.3 INSTALLATION AND CONNECTION (FOR BASE STATION)

### Connection Diagram

This diagram shows the connections for a base station.

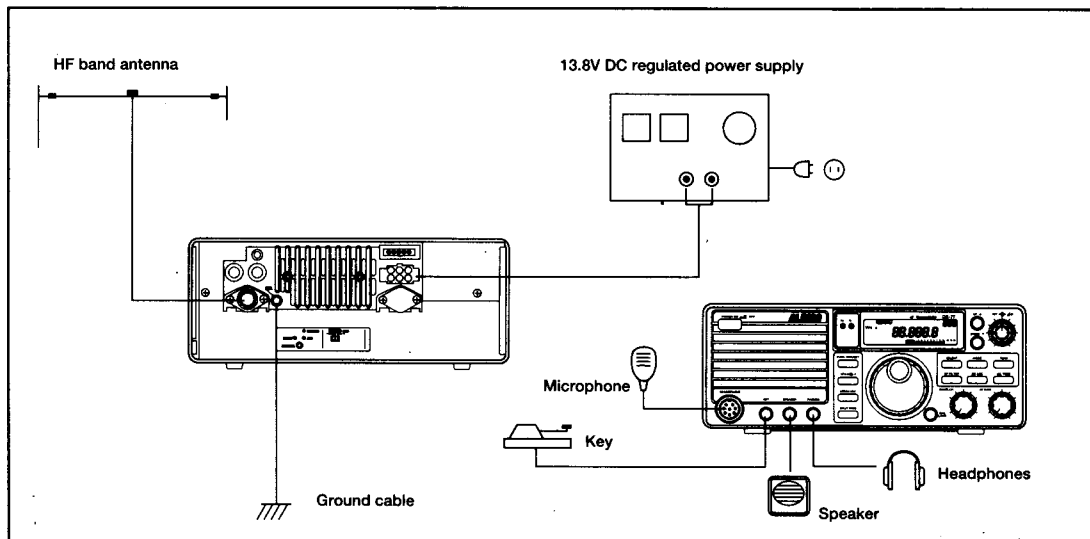

### Procedure

#### 1. Connecting an antenna and ground cable

- Antenna connection

Use a properly-adjusted (low SWR) antenna to obtain optimum performance from the transceiver. A 50 ohm impedance coaxial cable with UHF plugs is required for this connection.

 *Tip: It is recommended to use an optional manual antenna tuner (EDX-1) or automatic antenna tuner (EDX-2) for proper antenna matching.*

- Ground connection

To prevent electric shock hazard and radio interference with other electronic appliances, bury a rod or copper plate under the ground and connect it to the transceiver **GND** terminal. Use a heavy gauge, short cable for this connection.

 **Warning:** Do not ground the equipment on gas pipes, electrical conduits, or plastic water pipes.

## 2. Connecting a telegraph key

Connect a 3.5 mm diameter stereo plug to the **KEY** jack on the front panel. If using an electronic-keyer, pay attention to the polarity of the plug.

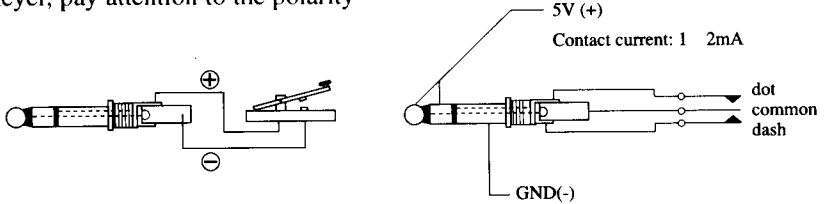

## 3. Connecting an external speaker (if not using the internal speaker)

Connect a 3.5 mm diameter mono plug to the **SPEAKER** jack on the front panel. Use a 3 W or higher external speaker with 8 ohm impedance.

 *Note: When an external speaker is used, no sound is heard from the internal speaker.*

## 4. Connecting headphones

Connect a 3.5 mm diameter mono or stereo plug to the **PHONES** jack on the front panel.

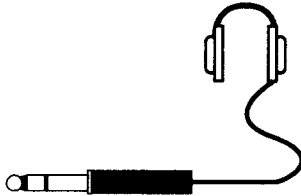

 *Note: When headphones are used, no sound is heard from the speaker.*

## 5. Connecting a DC regulated power supply

This transceiver is designed to operate on a 13.8 V DC regulated power supply. Use the supplied power cable to connect the transceiver and a DC power supply.

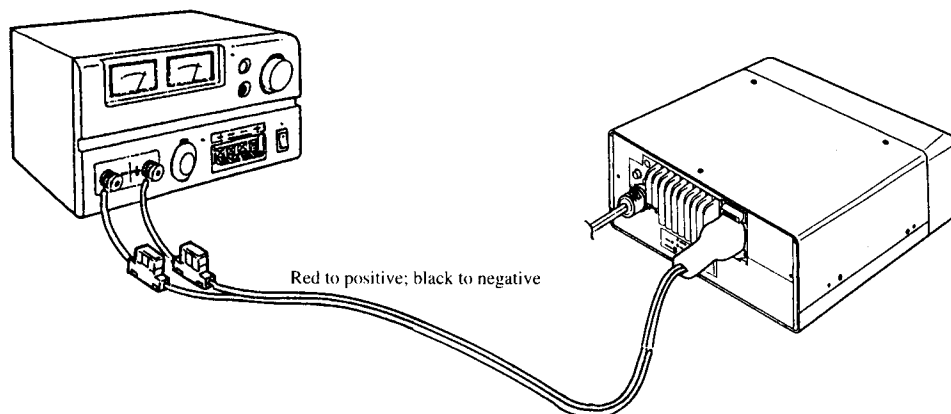

**Warning:** Before connecting, be sure to turn off the transceiver and DC power supply.

- Recommended DC regulated power supplies (see "OPTIONS")
  - DM-1350Z (Input 220 V AC)
  - DM-1350T (Input 120 V AC)
- Replacing the fuse
  - Use a 20 A blade-type fuse.

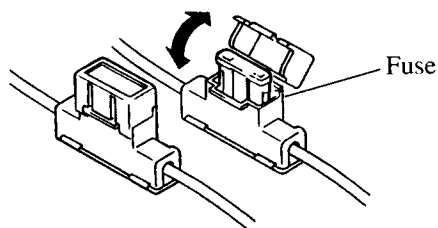



## 1.4 INSTALLATION AND CONNECTION (FOR MOBILE OPERATION)

### Connection Diagram

This diagram shows the connections for mobile operation.

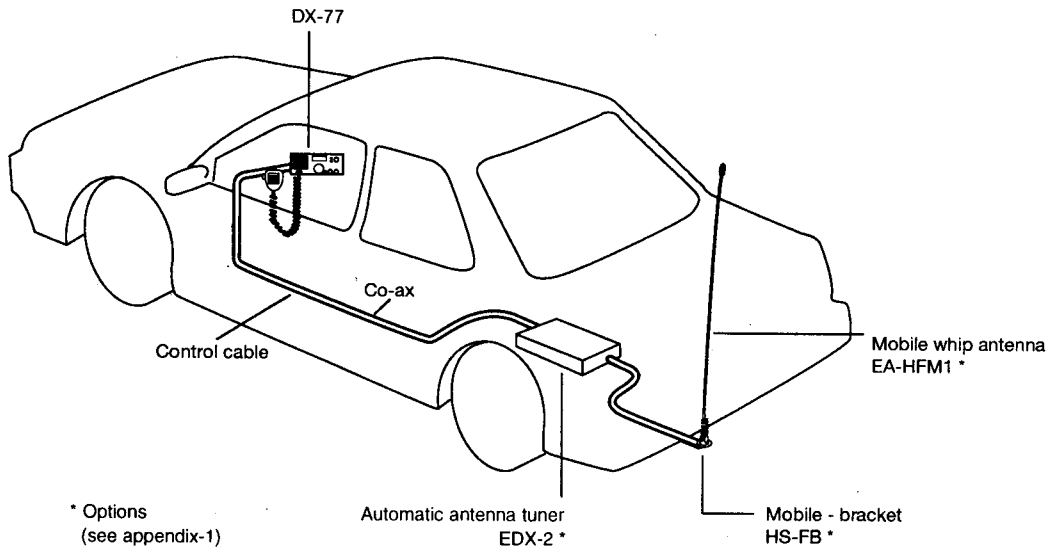

### Procedure

#### 1. Installing an antenna

Use a properly-adjusted (low SWR) antenna to obtain optimum performance from this receiver.

1. Secure a commercially-available antenna base in a proper position on your car.
2. Ground the antenna base.



**Warning: A ground is indispensable for HF antennas.**

3. Connect the antenna and transceiver using a 50 ohm impedance coaxial cable with UHF plugs.

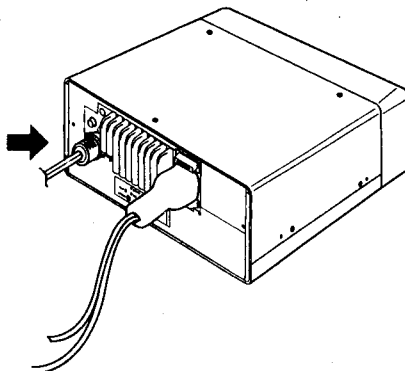

### 3. Connecting the power cable

**Caution:** Use a 12 V car battery to operate the transceiver.

1. Connect the supplied power cable directly to the car battery.

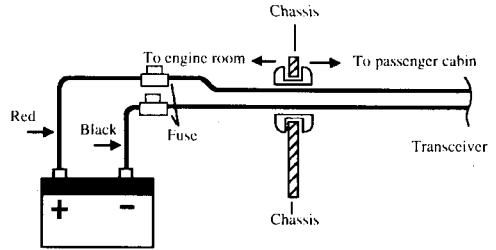

**Note:** If threading the cable through wiring holes, use grommets to prevent the cable from coming in contact with the car chassis.

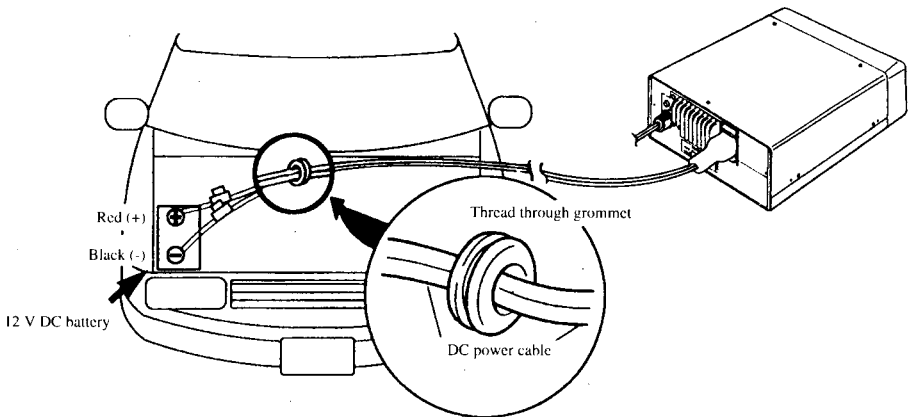

**Caution:** ■ If using a 24 V car battery, be sure to convert the voltage to 12 V DC with a DC/DC converter.  
 ■ Do not connect the power cable to a cigarette lighter connector because the power supply is unstable.

### 4. Connecting the accessories

- ➡ ● Microphone, page 1-11
- Telegraph key, page 1-4
- External speaker, page 1-4

**Tip:** The DX-77 is designed to filter ignition noise with the noise blanker (NB). However, if you pick up excessive ignition noise from your car, it is recommended to use a resistor spark plug.

# 1.5 CONTROLS, CONNECTORS, AND DISPLAY

## Front Panel

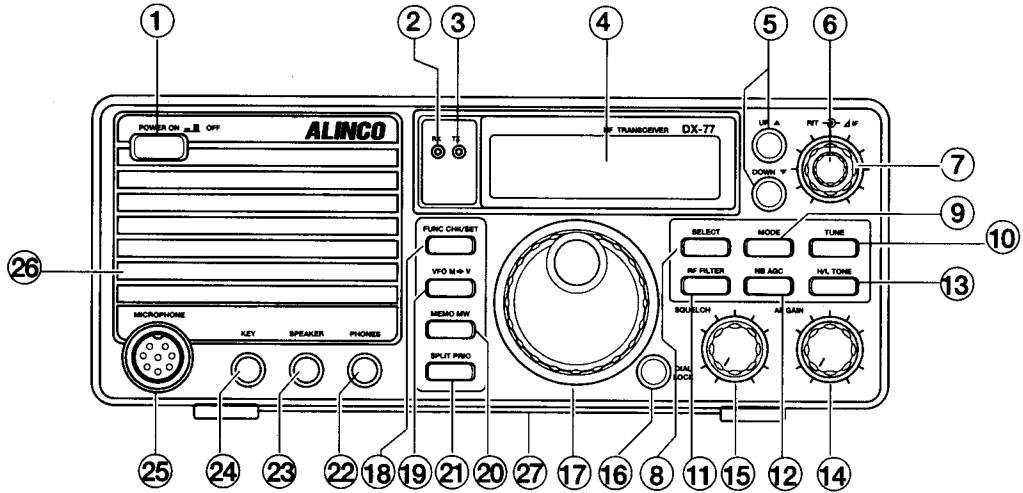

- |                             |  |
|-----------------------------|--|
| 1. <b>POWER switch</b>      | Turns the power on/off.  |
| 2. <b>RX LED</b>            | Lights green when signals are received or squelch is open (unmuted).   |
| 3. <b>TX LED</b>            | Lights red when transmitting the signal, and the brightness indicates the ALC peak level.  |
| 4. <b>LCD Display</b>       |  |
| 5. <b>UP/DOWN key</b>       | Press to select memory channels and amateur bands, and to change frequency in 1 MHz and 100 kHz increments. Also used to select the transceiver's settings in the <b>SET</b> mode. |
| 6. <b>RIT control knob</b>  | Fine-tunes the reception frequency within a range of $\pm 1.0$ kHz.  |
| 7. <b>Δ IF control knob</b> | Rotate to eliminate the interference by shifting the receiver IF pass band.  |

- 
- 8. SELECT key** Press to select the function of the **UP/DOWN** keys in the following modes:
- **VFO** mode  
Dial tuning→Memory channel No.→Band→1 MHz step→100 kHz step.
  - **MEMORY** mode  
Memory channel No.→Band→1 MHz step→100 kHz step→Dial tuning.
- 9. MODE key** Press to select the **LSB, USB, CWL, CWU, AM,** or **FM** modes.
- 10. TUNE key** To start antenna tuning when external automatic tuner is equipped for proper antenna matching.
- 11. RF key  
(preamplifier/  
attenuator)** Press to adjust receiver's front-end gain by switching between the preamplifier and attenuator. Pressing this key will change gain in the following: +10 dB, 0 dB, -10 dB, and -20 dB. After pressing the FUNC key, press this RF key to select a filter in the **CW** and **AM** mode.
- 12. NB key** Press to turn the NB (noise blanker) on/off. After pressing the FUNC key, press this **NB** key to select the **AGC** recovery time.
- 13. H/L key** Press to decrease the RF output power to about 1/10. After pressing the FUNC key in the FM mode, press this **H/L** key to encode the CTCSS tone to access repeaters. (EJ-34U required; see appendix-1)
- 14. AF gain control knob** Rotate to adjust volume.
- 15. SQL control knob** Rotate to eliminate noise when no signal is received.
- 16. DIAL LOCK key** Press to lock the main tuning dial to prevent accidental frequency change.
- 17. MAIN tuning dial** Rotate to select transmit/receive frequencies.
- 18. FUNC key** Press to access the green-marked key functions. Hold down to monitor the transmit frequency during reception. Press once then press and hold this key for 1 second to access the SET mode.

- 
- 19. VFO key** Press to switch from the MEMORY to VFO modes. In the VFO mode, press this key to switch between the VFOA and VFOB. After pressing the FUNC key, press the VFO key to transfer data from the selected memory channel to current VFO. (Use UP/DOWN keys to select the memory channel) Hold down to overwrite the VFO A data over the VFO B data, and vice versa.
- 20. MEMO key** Press to switch between the VFO and MEMORY modes. After pressing the FUNC key, press the MEMO key to program a memory channel. Hold down to erase the data in a memory channel.
- 21. SPLIT key** In the VFOA mode, press this key to use the VFOA for reception and VFOB for transmission, or vice versa. If a memory channel has been programmed from a SPLIT activated VFO, the memory remembers the split TX/RX frequencies, unless SPLIT is deactivated temporarily with this key. After pressing the FUNC key, press the SPLIT key to access the PRIORITY mode.
- 22. PHONES jack** For connecting external headphones. Takes 8 to 32 ohm impedance headphones.
- 23. SPEAKER jack** For connecting an external speaker. Takes 8 to 16 ohm impedance speakers.
- 24. CW-KEY jack** For connecting a telegraph key or manipulator paddle for internal electronic-keyer (option EJ-33U).
- 25. MICROPHONE connector** For connecting a microphone.
- 26. Internal speaker** Received signals are heard from here.
- 27. Tilt-up stand** Tilt up this stand for best operating position.

## Connecting the Microphone

1. Plug the microphone into the microphone connector of the body.

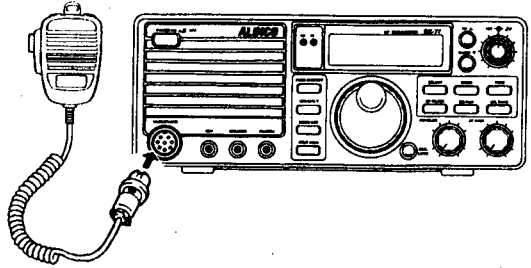

2. Tighten the screw on the connector to secure the connection.

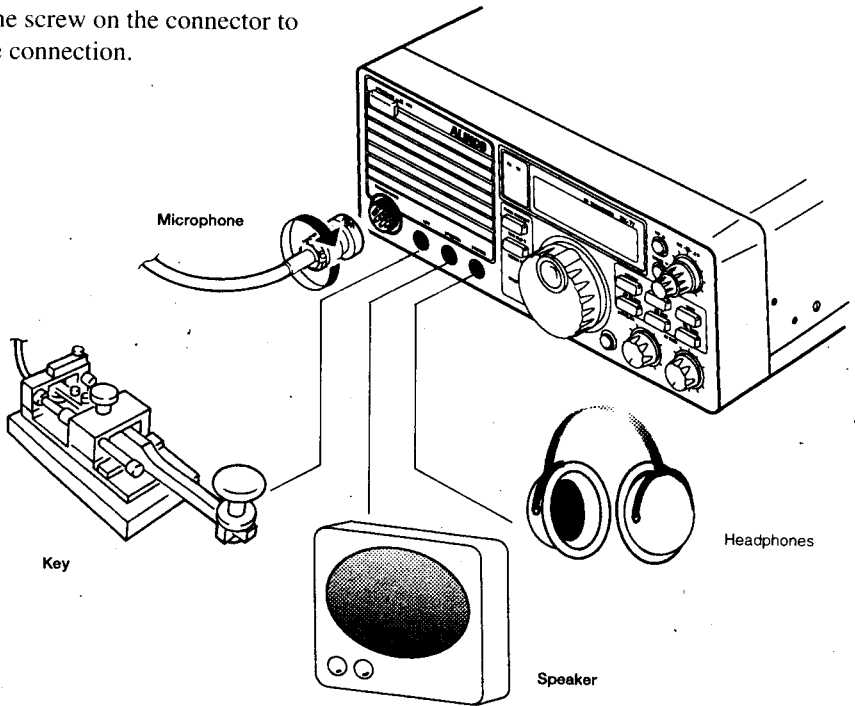

 *Tip:*

### Connector pin assignment

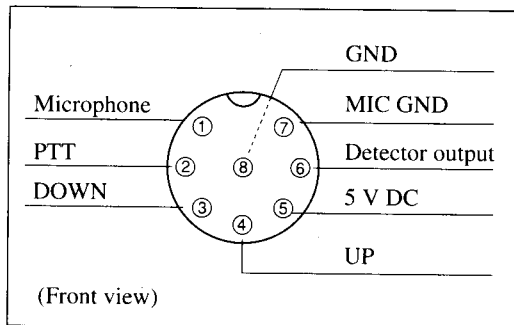

## Rear Panel Connectors

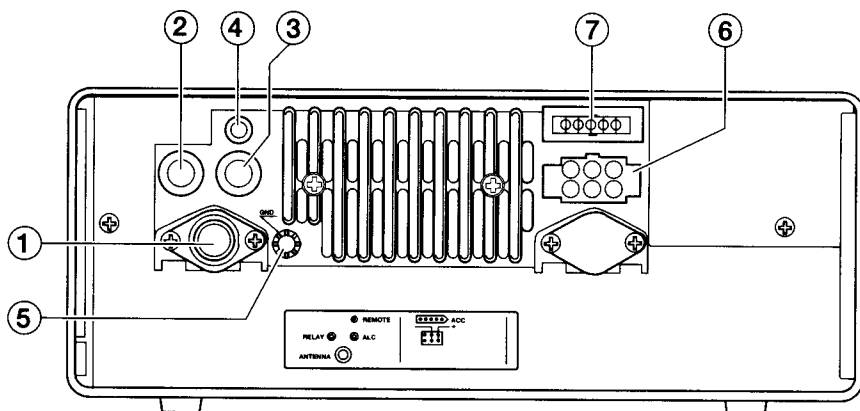

- |                                       |   |
|---------------------------------------|---|
| <b>1. ANTENNA connector</b>           | For connecting an HF band antenna. Takes a 50 ohm impedance coaxial cable with UHF plug.  |
| <b>2. RELAY (external relay) jack</b> | For connecting external equipment such as a linear amplifier for switching between reception and transmission. Takes a phono-plug.                          |
| <b>3. External ALC input jack</b>     | For connecting the phono-plug from the amplifier <b>ALC</b> circuit when a linear amplifier is used. The <b>ALC</b> input voltage must be from 0 to -3 VDC. |
| <b>4. REMOTE jack</b>                 | For use in data control for remote operation of transceiver functions. Option ERW-4 cable required.   |
| <b>5. GND (ground) terminal</b>       | For connecting a ground cable.  |
| <b>6. Power connector</b>             | For connecting the supplied DC power cable. Input voltage must be 13.8 VDC $\pm$ 15%.   |
| <b>7. ACC (accessory) connector</b>   | For connecting peripherals such as an external automatic antenna tuner.   |

## Microphone

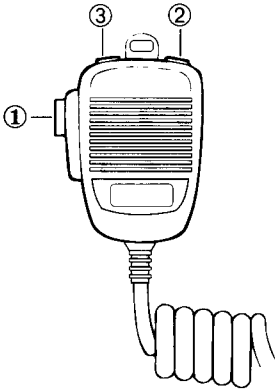

### 1. PTT key

Push to transmit, and release to receive. Push to stop scanning.

### 2. UP key

In the **VFO** mode, press this key to change frequency upwards in the selected frequency step. In the **MEMORY** mode, press this key to change memory channel upwards by one channel. Hold down longer than one second to start scanning.

### 3. DOWN key

In the **VFO** mode, press this key to change the frequency downwards in the selected frequency step. In the **MEMORY** mode, press this key to change memory channel downwards by one channel. Hold down longer than one second to start scanning.

## Side

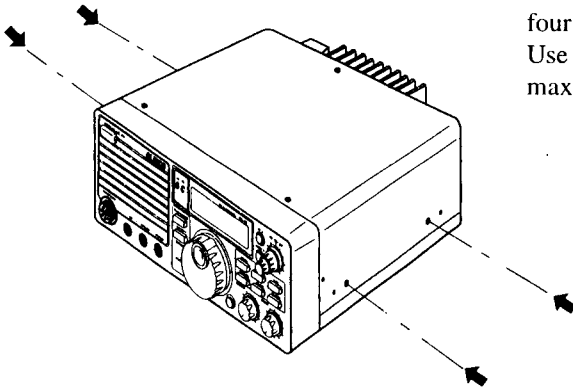

For fastening DX-77 to a fixed location, four holes are provided, two on each side. Use threaded screws of 5 mm diameter × max 10 mm length.



## Display

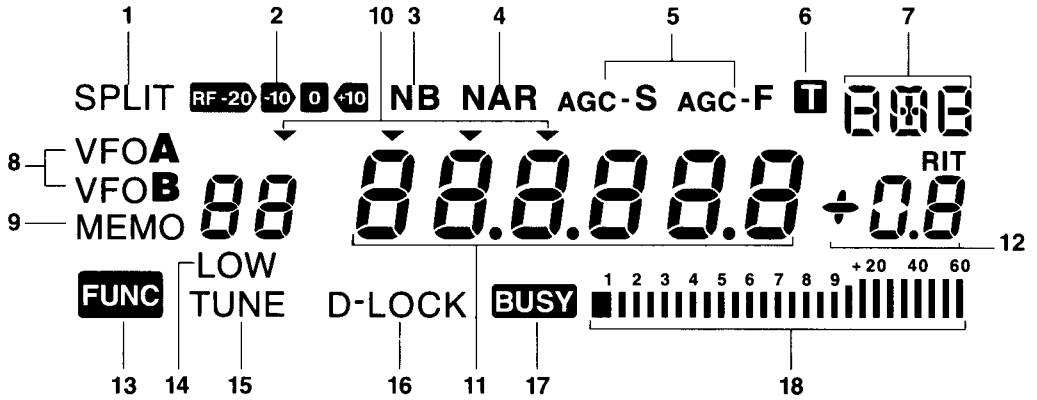

1. **SPLIT** Appears in the split-frequency operation.
2. **RF-20 -10 0 +10** Indicates the receiver's front-end gain or attenuation.
3. **NB** Appears when the **NB** (noise blanker) is activated.
4. **NAR** Appears when the narrow filter is used in the **SSB**, **CW**, and **AM** modes.
5. **AGC-F, AGC-S** "AGC-F" appears when the **AGC** recovery time is set to fast. "AGC-S" appears when the **AGC** recovery time is set to slow.
6. **T** Appears during the tone encode operation.
7. **LSB** Indicates the selected mode, including **LSB**, **USB**, **CWL**, **CWU**, **FM**, and **AM**.
8. **VFOA, VFOB** Indicates the selected **VFO** mode.
9. **MEMO 88** Appears in the **MEMORY** mode, indicating the selected memory channel.
10. **▼** Appears above the frequency digit you can change with the **UP/DOWN** keys.
11. **88.888.8** Indicates the transmit/receive frequency.

- 
12. **+0.8<sup>RIT</sup>** Indicates the **RIT** shift frequency.
13. **FUNC** Appears when a secondary-function key is activated.
14. **LOW** Appears when the output power is set to low.
15. **TUNE** Appears while the external automatic antenna tuner is being tuned.
16. **D-LOCK** Appears when the **DIAL LOCK** function is activated.
17. **BUSY** Appears when squelch is unmuted.
18.  **S** meter: Indicates relative received signal strength  
**RF** meter: Indicates relative output power level.

## Controls Quick Reference

	This key only	FUNC+this key (See notes)	FUNC+FUNC+this key (See notes)
FUNC	Accesses the FUNC mode *Monitors transmit frequency.	Accesses <b>SET</b> mode.	
VFO	Switches between <b>VFO A</b> and <b>VFO B</b> . Accesses to VFO mode. *activates <b>VFO A=B</b> function.	Transfers memory to VFO.	Set frequency steps ( <b>UP/DOWN</b> tuning step).
MEMO	Accesses <b>MEMORY</b> mode. *Erases memory channel.	Enter memory channel.	Memory overwrite protection ON/OFF. Memory frequency access protection ON/OFF.
SPLIT	SPLIT function ON/OFF. *QUICK OFFSET function.	<b>PRIORITY</b> function ON/OFF.	Selects SCAN mode (condition for stopping and resuming scan). Group memory scan ON/OFF.
SELECT	Changes cursor position for setting band/memory/frequency with <b>UP/DOWN</b> keys.		Changes LCD backlight. Beep ON/OFF.
MODE	Selects the <b>LSB, USB, CWL, CWU, AM, FM</b> modes.		Automatic <b>USB/LSB</b> selection <b>ON/OFF</b> .
TUNE	Starts tuning an external automatic antenna tuner. (option)		Switches internal Electronic-keyer ON/OFF (optional). Press again to select internal electronic-keyer speed. (optional)
RF	Changes <b>RF</b> gain.	Switch to narrow filter ON/OFF.	Changes break-in mode. Selects CW offset and the sidetone.
NB	<b>NB</b> (noise blanker) ON/OFF.	Changes AGC recovery time.	Selects CTCSS tone frequency.
H/L	Changes <b>RF</b> output power.	Switches CTCSS tone ON/OFF.	Switches speech processor ON/OFF.
DIAL LOCK	Locks main dial tuning.		Transmitter inhibit ( <b>PTT</b> key lock) ON/OFF.

\* Hold down longer than 1 second.

\*\*Hold down longer than 2 seconds.

*Notes: FUNC+this key: Press FUNC key, then press this key.*

*FUNC+FUNC+this key: Press FUNC key once, then press again and hold the FUNC key longer than 1 seconds and press this key.*

# Chapter 2 Communications

## 2.1 RECEPTION BASICS

### Introduction

Reception is a basic transceiver operation. In this section, you can familiarize yourself with the operation of controls used for reception.

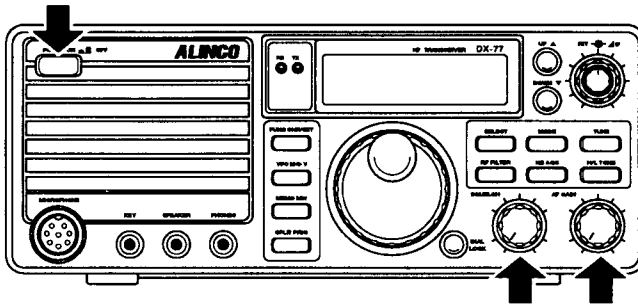

← The arrows indicate the controls used in this procedure.

### Procedure

#### 1. Turning power on/off

 **Note:** Make sure that all antenna and power connections are correct before turning the power on.

1. Press the **POWER** switch.  
The LCD will come on.



 **Caution:** Be sure to turn off the transceiver before turning off the regulated power supply or turning the ignition key to the off position.

 **Note:** If the power supply drops to below 10 V, turn the power off, and turn on again. When the power is turned off, leave for at least 5 seconds before turning on again.

#### 2. Adjusting volume

- Turn the **AF gain** control knob clockwise to increase the speaker volume.
- Turn the **AF control** knob counterclockwise to decrease the speaker volume.

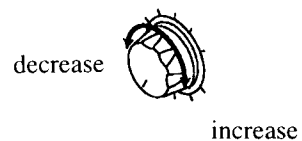

#### 3. Adjusting Squelch

1. Turn the **SQL** knob clockwise until background noise just disappears.
  - The more clockwise the **SQL** control knob is turned, the stronger the received signal is. The **SQL** should be turned fully counterclockwise when receiving weak or unstable signals. The **RX LED** lights green while the squelch is open (unmuted).

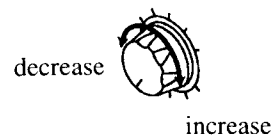

## 4. Selecting mode (modulation)

- To select **SSB** mode

Pressing the **SSB** key will switch you between the **LSB** and **USB** modes. Select either mode.

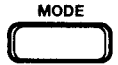

 *Tip: The **SSB** mode is most frequently used in HF bands. Usually, the **LSB** mode is used below 7 MHz amateur band, and the **USB** mode is used above 14 MHz amateur band.*

- To select the **AM** mode

Pressing the **AM/FM** key will switch you between the **AM** and **FM** modes. Select the **AM** mode.

 *Tip: This mode is commonly used to listen to MF and HF broadcasts.*

- To select the **FM** mode

Pressing the **AM/FM** key will switch you between the **AM** and **FM** modes. Select the **FM** mode.

 *Tip: The **FM** mode occupies a wide bandwidth; this will allow reproduction of high quality sound that is less affected by noise. The **FM** mode is often used in 29 MHz.*

- To select **CW** mode

**CWU** lets you receive **CW** signals on the upper side of the carrier frequency, while **CWL** on the lower side of the carrier frequency.

 *Tip: The **CW** mode is used in Morse communications.*

 *Tip: This transceiver remembers the last used mode.*

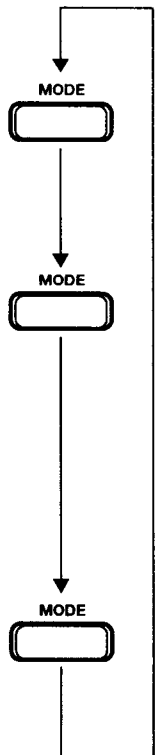

## 5. Selecting amateur bands

Amateur bands are frequency bands that hams are allowed to use. This transceiver covers 9 amateur bands ranging from 1.8 MHz to 28 MHz bands.

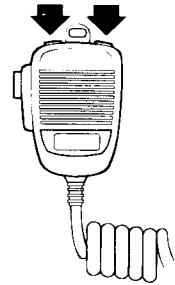
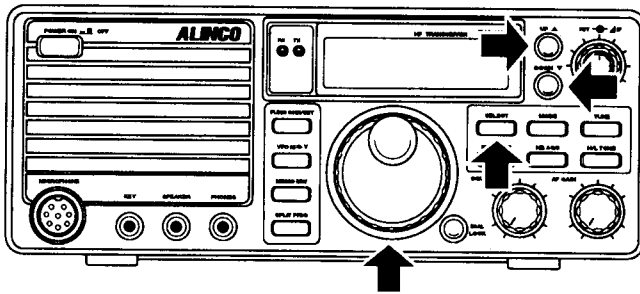

1. Press the **SELECT** key repeatedly until two cursors ▼ ▼ appear above the MHz frequency indication.

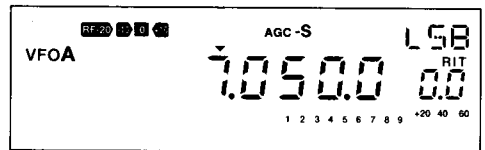

2. Press the **UP/DOWN** keys or push the **UP/DOWN** key of the microphone to select the desired band.

*Tip:* When you select a band, the LCD will display the last-used frequency in that band.

*Note:* When a band is changed, you might hear the relay click. This is normal.

3. Press the **SELECT** key repeatedly until ▼ disappears.

- Each time the **SELECT** key is pressed, ▼ shifts in the following manner:

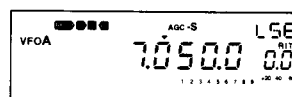
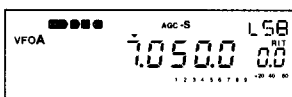
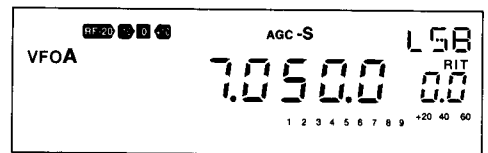

▼ above MHz frequency indication      ▼ above 100 kHz frequency indication

- Default settings (Default band, frequency and mode for both **VFO A** and **B**)

Band	default (Mode)	10	10.100.0 MHz (USB)	24	24.900.0 MHz (USB)
1.8	1.9000.0 MHz (LSB)	14	14.100.0 MHz (USB)	28	28.100.0 MHz (USB)
3.5	3.6000.0 MHz (LSB)	18	18.100.0 MHz (USB)	29	29.100.0 MHz (USB)
7	7.1000.0 MHz (LSB)	21	21.100.0 MHz (USB)		

## 6. Setting a frequency (Tuning)

- Using **VFO's**
  - Pressing the **VFO** key will switch you either the **VFO A** or **VFO B**. Select either **VFO**.

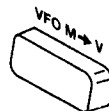

- ✎ *Tip: This transceiver has the **VFO** and **MEMORY** modes (see section 3-1). In the **VFO** mode, different frequencies and settings can be set in each individual **VFO A** and **VFO B**.*

- Using the main tuning dial
  - Turn the main tuning dial clockwise to increase the frequency.
  - Turn the main tuning dial counterclockwise to decrease the frequency.

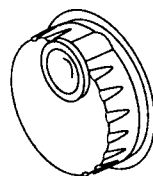

- ✎ *Tip: In the **SSB** and **CW** modes, rotating the dial will change the frequency in 10 Hz steps (One full rotation will change frequency by 2 kHz). In the **AM** and **FM** modes, rotating the dial will change the frequency in 100 Hz steps (One full rotation will change frequency by 20 kHz).*

- Using the **UP/DOWN** key

1. Check to see that no ▼ is displayed. If displayed, press the **SELECT** key repeatedly until it disappears.
2. Press the **UP** key to increase the frequency.  
Press the **DOWN** key to decrease the frequency.



- ✎ *Tip: Frequency step is different by mode. The steps can be selected in the **SET** mode (see pages 6-10, 11, 12). The default is 1 kHz for **SSB** and **CW**, 1 kHz for **AM**, and 2.5 kHz for **FM**.*

- Using the **UP/DOWN** keys on the microphone

1. Check to see that no ▼ is displayed. If displayed, press the **SELECT** key repeatedly until it disappears.
2. Press the **UP** key to increase the frequency.  
Press the **DOWN** key to decrease the frequency.

- ✎ *Tip: The **UP** and **DOWN** keys of the microphone use the same frequency steps as the **UP/DOWN** keys.*

- ✎ *Tip: In mobile operation, the selected frequency may be accidentally changed by the vibration of your car, etc. To prevent this, press the **DIAL LOCK** key to lock the main tuning dial. While the dial is locked, tuning is still be possible with the **UP/DOWN** dial and **RIT** control knob (see page 5-4).*

## Exercise

- Try receiving a 28.200 MHz signal in the **AM** mode.

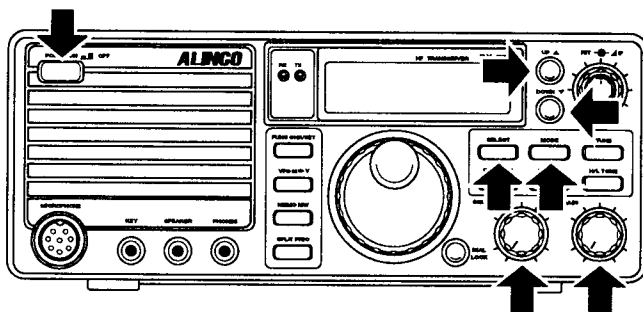

1. Make sure that antenna connection is correct.

2. Turn the power on.

3. Rotate the **AF** control knob to adjust the volume.

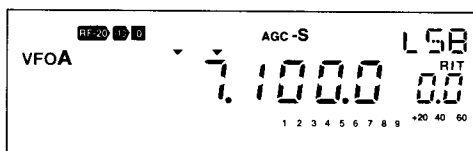

4. Press the **SELECT** key repeatedly until ▼ ▼ appears above the MHz frequency indication (amateur band selection position).

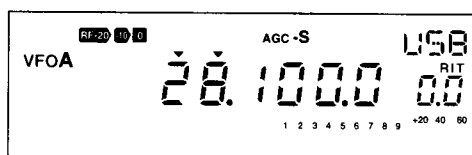

5. Press the **UP/DOWN** keys to select the 28 MHz band.

6. Press the **SELECT** key repeatedly until ▼ appears above the 100 kHz frequency indication.

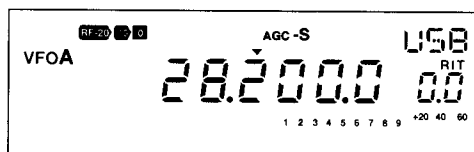

7. Press the **UP/DOWN** to set the frequency to 28.2 MHz.

8. Press the **MODE** key to select the **AM** mode.

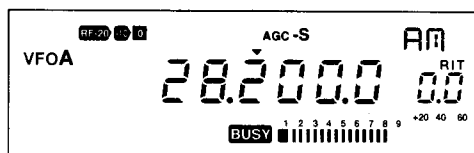

9. Turn the **SQL** control knob clockwise until the background noise just disappears.

- To receive the neighbouring frequencies, use the main tuning dial.

- Likewise, try receiving different frequencies in each band.



*Tip: This transceiver has a built-in general coverage receiver that covers 500 kHz to 30 MHz. By activating the receiver, you can enjoy MF and HF broadcasts in the **AM** mode.*



## Getting Familiar with Useful Functions

In HF band, receive conditions vary not only with band and mode but with time and season. To obtain optimum signal reception, get familiar with and take full advantage of these versatile functions.

### RF (RF gain)

1. Press the **RF** key to select one of the receiver's front-end gain settings.

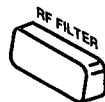

- Each time the **RF** key is pressed, the following icon will appear on the LCD:

 A 10 dB preamplifier is activated. This mode will be useful when receiving weak signals.

 This is the factory's default setting. Usually select this setting.

 A 10 dB attenuator is activated. When receiving strong local signals, select this setting.

 A 20 dB attenuator is activated. Select this setting when receiving very strong local signals or when you find such signals near the received signal.

### AGC (Automatic Gain Control)

- The **AGC** function automatically adjusts the gain of strong signals and weak signals so that you can hear them at the same volume.

1. Press the **FUNC** key, then press the **NB** key to select either the **AGC-S** or **AGC-F** mode.



 **Note:** If there is no key entry within 5 seconds after **FUNC** appears, the function will be canceled.

- **AGC-S** mode: The **AGC** recovery time is long.
- **AGC-F** mode: The **AGC** recovery time is short.

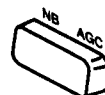

 **Tip:** Usually, the **AGC-S** mode is selected for the **SSB** and **AM** modes. This function will be disabled in the **FM** mode.

## RIT (Receiver Incremental Tuning)

- The **RIT** function allows you to change the receive frequency within a range of  $\pm 1.0$  kHz, for example, when the other station shifts the transmit frequency.

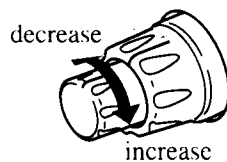

1. Rotate the **RIT** control knob to adjust the frequency.  
The **RIT** control knob is the centre axis of the upper-right corner knob.

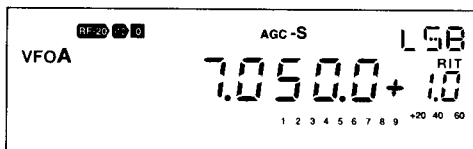

➞ *IF shift, filter, and NB, pages 5-1, 2, 3.*

## 2.2 TRANSMISSION BASICS

### Introduction

This section explains the preparations and basic procedures for transmission. For details on how to transmit in each mode, see pages 2-10 to 2-24.

### Procedure

#### Transmitting in the voice mode (SSB and AM/FM)

1. Make sure that all antenna, power, and microphone connections are correct.
2. Turn the power on.
3. Using the normal reception procedure, select a clear frequency free of other stations or select the frequency of a station to communicate with.
4. Set the output power level if necessary (see page 2-9).
5. Push and hold the **PTT** key and speak into the microphone. The red **TX** LED will be lit.

 *Note: Speak 20 to 30 cm away from the microphone. Speaking too close to the microphone may increase distortion.*

 *Using the speech compressor, page 2-9*

 *Adjusting the microphone gain, page 7-2*

6. Release the **PTT** key to stop transmitting and return to receive.

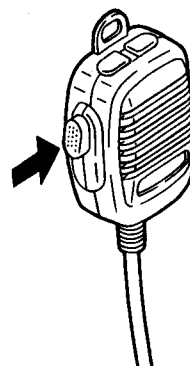

Push to transmit  
Release to receive

#### Transmitting in the CW mode

Keying will automatically start transmit.

1. Make sure that all antenna, power, and microphone connections are correct.
2. Turn the power on and set for reception.
3. Set the output power level if necessary (see page 2-9).
4. Set the desired **BREAK-IN** mode (see page 6-5).

 *Note: The default setting is the AUTO BREAK-IN mode, meaning the delay time for the SEMI BREAK-IN mode will be set automatically according to transmitting CW speed.*

5. Begin keying.  
The red **TX** LED will light.
6. Stop keying.  
Transmission will stop automatically.

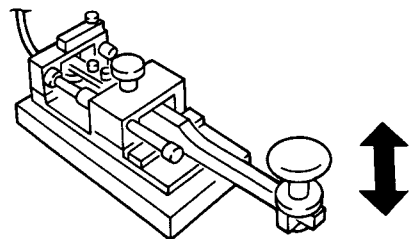

## Selecting output power level

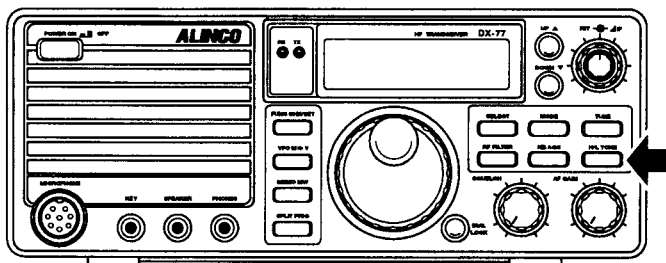

- Pressing the **H/L** key will switch you between the **HIGH** and **LOW** modes. When the “LOW” icon is not displayed, the transceiver is set to the high output power level.



SSB, CW, FM	H	100
	L	10
AM	H	40
	L	4



### Tips: ■ *Speech compressor:*

*Increases talk power to enable clear and powerful transmission.  
This function can be activated only in the SSB or AM mode  
(see page 6-8 to set the speech compressor).*

### ■ *OFF BAND display:*

*Stops transmission when you attempt to transmit outside of the amateur band.  
The LCD will display the following:*

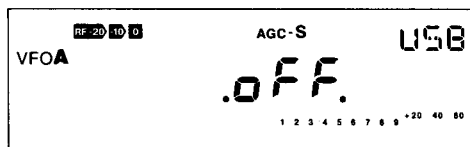

## 2.3 SSB OPERATION

### Introduction

The **SSB** (Single Side Band) mode is most frequently used for voice communication in HF bands. However, when first trying to tune in the **SSB** mode, you may receive noisy and unclear signals. But as you practice receiving in this mode, you will learn the art of tuning, and will soon be able to communicate with even overseas stations.

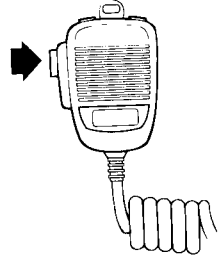
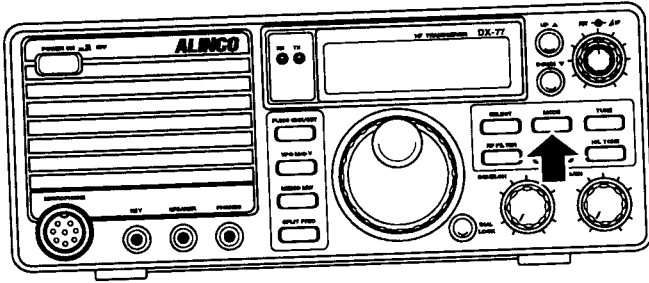



### Procedure

 *Note: Make sure that all antenna, power, and microphone connections are correct.*

1. Turn the power on.
2. Select the desired amateur band (see page 2-3).
3. There are two types of **SSB** mode: **USB** (Upper-Side-Band) and **LSB** (Lower-Side-Band).

The **LSB** or **USB** mode will be automatically selected according to the selected band, unless other mode has been selected before in which case press the **MODE** key to select **USB** or **LSB**.

 *Note: If the Automatic USB/LSB Selection function is set to off, the last-used SSB mode is recalled.*

 *Tip: Usually, the **LSB** mode is used below 7 MHz amateur band, and the **USB** mode is used above 14 MHz amateur band.*

 *Note: The transceiver's squelch circuit interacts with the S meter. Therefore, if the AGC-F mode is selected in the SSB mode, squelch may be muted and unmuted according to the signal strength. To prevent this, it is recommended to select the AGC-S mode rather than the AGC-F mode. In CW mode, we suggest that the squelch knob set to fully counterclockwise until you get familiar with the operation.*

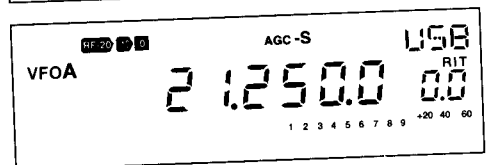
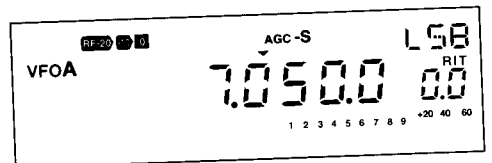

---

**4.** Tune in a station to communicate with.

- Select a frequency at which the signal from the station is clearly heard.



*Note:* ● *Be sure to set the RIT knob back to the original position after contact is made. Otherwise, your frequency will shift off the other station's frequency on the next contact.*

- *Check to see the frequency is not used by other stations before transmitting.*

**5.** Push and hold the **PTT** key and speak into the microphone.

The red **TX** LED will be lit. The reading on the **RF** meter and the brightness of the **TX** LED will change according to the intensity of your voice (see page 1-8).



*Note:* *Speaking too close to the microphone or too loudly may increase distortion and reduce clarity.*

**6.** Release the **PTT** key to return to receive.



*Split-frequency operation, page 2-23*

## 2.4 PRACTICAL TECHNIQUES FOR SSB OPERATION

### Introduction

In **SSB** operation, you may encounter various problems such as poor propagations and interferences. This section explains how to use the special functions to overcome these problems.

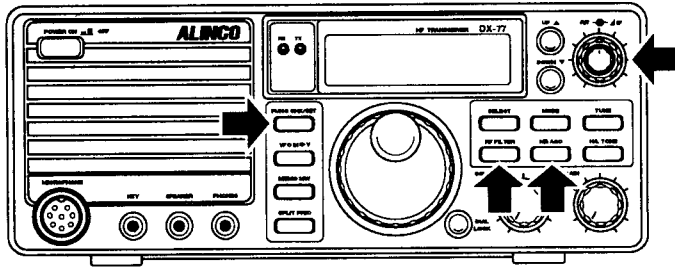

### Eliminating Interference (QRM)

#### Activating the IF SHIFT function

This function eliminates interference by shifting the filter pass band without changing the receive frequency.

Turn the  $\Delta$ IF knob clockwise or counterclockwise to lessen interference. The  $\Delta$ IF knob is the outer rim of the upper-right corner knob.

#### Activating the RF attenuator

When the received signal is noisy, it is possible that you are picking up another strong signal from nearby.

Press the **RF** key to activate the attenuator to a desired level.

## Communicating in Bad Conditions

In HF band, how radio waves travel changes according to time, season, and propagation paths. For example, signals from the other station may fade or alternate between strong and weak. In this case, perform the following.

### Using the RF preamplifier

1. Press the **RF** key repeatedly until  appears.

The preamplifier will come on.

### Selecting the AGC-F mode

In the **SSB** mode, the **AGC-S** mode is usually selected. However, if there are strong signals or noise near a weakly received signal, the signal is suppressed by the strong signals or noise. In this case, select the **AGC-F** mode to improve receiving conditions.

1. Press the **FUNC** key, then press the **NB** key repeatedly until the “AGC-F” icon appears.



*Note: If there is no key entry within 5 seconds after **FUNC** appears, the function will be canceled.*

## Communicating with Off-frequency Stations

When communicating with a group of stations at the same time (round-table QSO), each individual station uses a slightly different frequency. In this case, use the **RIT** function.

### Activating the RIT function

1. Rotate the **RIT** control knob to adjust your receive frequency.
  - The **RIT** operation does not change your transmit frequency so that the other station does not need to shift his receive frequency.

## Communicating in Pile-ups

Many stations may call one station at the same time. In this case, use the speech compressor so that the station can pick out your call.

### Using the speech compressor

1. Set the speech compressor to “ON” in the **SET** mode (see page 6-8).

The compressor will increase the talk power and increase the readability as well.



## 2.5 AM OPERATION

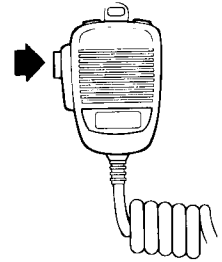
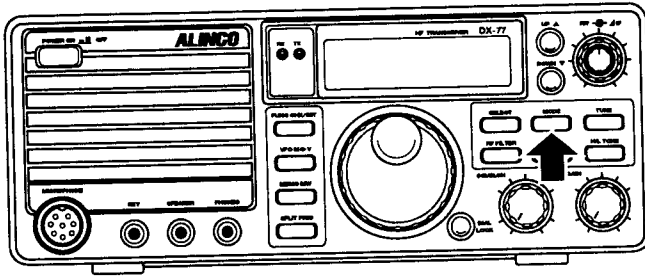

### Procedure

 **Note:** Make sure that all antenna, power, and microphone connections are correct.

1. Turn the power on.
2. Select the desired operating band (see page 2-3).
3. Press the **MODE** key to select the **AM** mode.

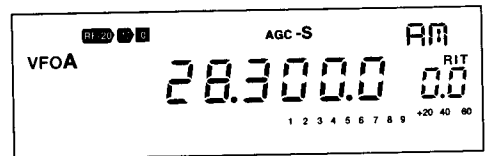

4. Tune in a station to communicate with.

 **Note:** Check to see the frequency is not used by other stations before transmitting.

5. Push and hold the **PTT** key and speak into the microphone.

The red **TX** LED will be lit. The reading of the **RF** meter and the brightness of the **TX** LED will change according to the intensity of your voice.

 **Note:** Speaking too close to the microphone or too loudly may increase distortion and reduce clarity. Speak such that the **RF** meter reading changes by 2 or 3 levels as opposed to not speaking.

6. Release the **PTT** key to return to receive.

 **Note:** The output power level in the **AM** mode is lower than in the other modes (see page 2-9).



**Tips:** ● Using the speech compressor will increase the readability of your transmit signal (see page 6-8).

## 2.6 GENERAL COVERAGE RECEIVER OPERATION

### Introduction

This section explains procedures for receiving MF and HF broadcasts using the general coverage receiver.

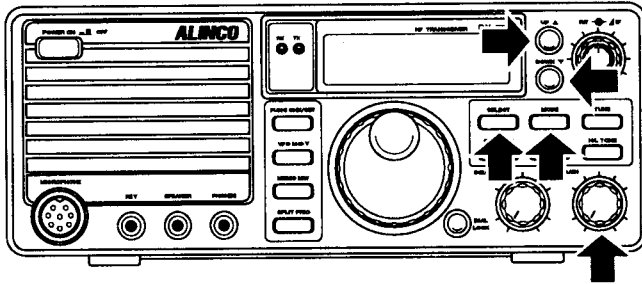

### Procedure

Example: Receiving a 670 kHz MF broadcasts

1. Make sure that all antenna and power connections are correct.
2. Turn the power on.
3. Press the **SELECT** key repeatedly until ▼ appears above the 1 MHz frequency indication.
4. Press the **UP/DOWN** key until set as shown on the right.
5. Press the **SELECT** key to display ▼ above the 100 kHz frequency indication.
6. Press the **UP/DOWN** key until set as shown on the right.
7. Press the **SELECT** key repeatedly until ▼ disappears.
8. Press the **MODE** key to select the **AM** mode.
9. Rotate the **UP/DOWN** keys or the main tuning dial until set as shown on the right.
10. Rotate the **AF** gain knob to adjust the volume.

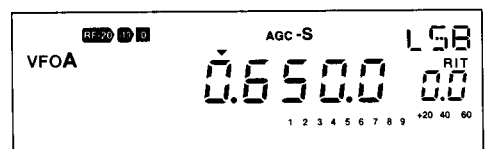
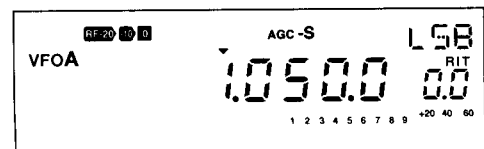
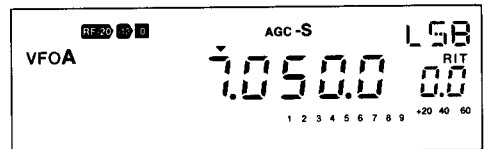

## 2.7 FM OPERATION

### Introduction

In the FM (Frequency Modulation) mode, you can enjoy high quality sound that is less affected by noise. This mode is frequently used in the 29 MHz band as well as VHF and UHF bands.

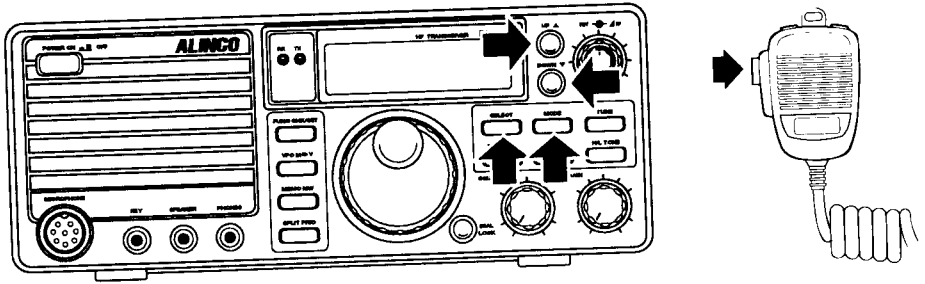

### Procedure

 *Note: Make sure that all antenna, power, and microphone connections are correct.*

1. Turn the power on.
2. Adjust squelch level.

 *Note: If squelch level (threshold) is set too high, the transceiver will not be able to pick up weak signals.*

3. Select the desired operating band (see page 2-3).

 *Note: In the FM mode, this transceiver is designed to use the super narrow ( $\pm 2.5$  kHz deviation).*

4. Press the **MODE** key to select the **FM** mode.

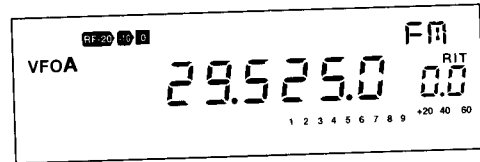

5. Select the desired frequency.

 *Note: Check to see the frequency is not used by other stations before transmitting.*

 *Tip: When tuning, the UP/DOWN keys may be more useful than the main tuning dial. Frequency step for the UP/DOWN dial can be selected in the SET mode (see page 6-12).*

6. Push and hold the **PTT** key and speak into the microphone.

The red **TX** LED will be lit.

7. Release the **PTT** key to return to receive.

## 2.8 REPEATER OPERATION

### Introduction

This section explains procedures for transmitting through a repeater.

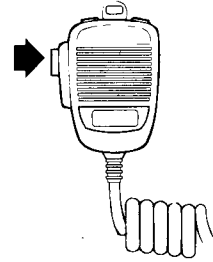
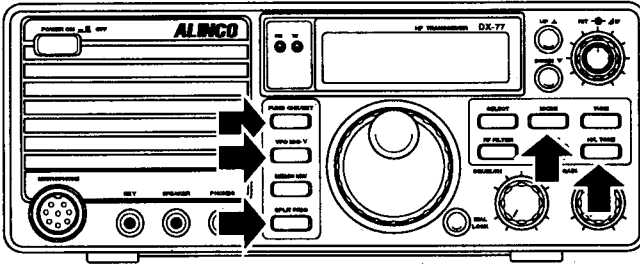

### Procedure

Example: Selecting 29.640 MHz for reception and 29.540 MHz for transmission

1. Make sure that all antenna, power, and microphone connections are correct.
2. Turn the power on.
3. Adjust squelch level.
4. Set 29.640 MHz in the **VFO A**.
5. Press the **MODE** key to select the **FM** mode.

6. Press the **FUNC** key, then press the **H/L** key (if CTCSS tone is required).  
**FM** will appear at the left of the "FM" icon.

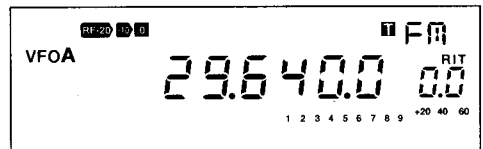

**Note:** If there is no key entry within 5 seconds after **FUNC** appears, the function will be canceled.

7. Select the proper CTCSS tone frequency. (See page 6-17)
  - A CTCSS tone encoder EJ-34U comes standard with the DX-77T; optional for the DX-77E.

8. While pressing and holding the **SPLIT** key, turn the **MULTI FUNCTION** dial or the main tuning dial to select "-0.100.0."

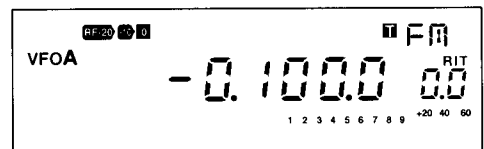

⇒ *QUICK OFFSET function, page 2-24*

9. Push and hold the **PTT** key and speak into the microphone.
10. Release the **PTT** key to return to receive.

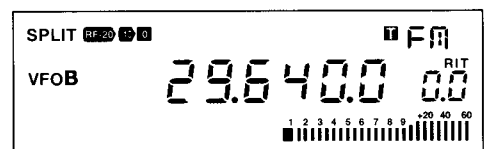

**Tip:** It is useful to store repeater frequencies in memory channels. Each memory channel can store a split frequency (see page 3-5).

## 2.9 CW OPERATION

### Introduction

In the **CW** (Continuous Wave) mode, you communicate with other stations by transmitting and receiving Morse code. The code is keyed with a telegraph key. Because of the code, you can more easily communicate with DX stations than in other modes.

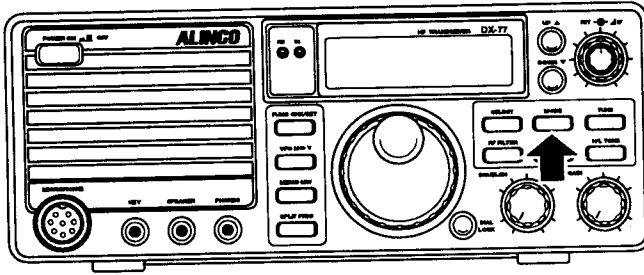

### Procedure

 *Note: Make sure that all antenna, power, and key connections are correct.*

1. Turn the power on.
2. Select the desired operating band (see page 2-3).
3. Press the **MODE** switch to select either the **CWL** or **CWU** mode.

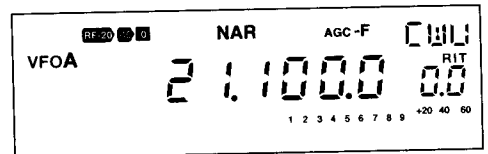

- The **CWL** mode switches reception from the upper sideband to the lower sideband; this is similar to the **LSB** mode, but suited to **CW** reception.
- The **CWU** mode switches reception from the lower sideband to the upper sideband; this is similar to the **USB** mode, but suited to **CW** reception.

---

#### 4. Select a frequency of a station to communicate with.

- Pressing and holding the **FUNC** key allows you to monitor your transmit frequency by sidetone.

While pressing the **FUNC** key longer than one second, press the telegraph key down and rotate the main tuning dial until the received signal and the sidetone are heard at the same pitch (zero-in operation).



*Tip: The sidetone can be selected from 400-1000 Hz in 50 Hz step in the **SET** mode.*



*Note: When tuning in a **CW** signal, be sure to tune in the correct side beat. You can hear the same signal on the opposite side beat which is separated at twice the side tone frequency. The correct beat is stronger, and is always on upper side when receiving in **CWL** and lower side when receiving in **CWU**.*

#### 5. Start keying.



*Tip: This transceiver has the **FULL BREAK-IN** and **SEMI BREAK-IN** modes. For the **SEMI BREAK-IN** mode, you can select one of eight levels including the **AUTO** mode, in which the delay time is set automatically.*

#### 6. Stop keying to receive.



*Adjusting the sidetone frequency, page 6-4*

## 2.10 PRACTICAL TECHNIQUES FOR CW OPERATION

### Introduction

In **CW** operation, you will encounter various problems such as poor propagations and interferences. This section explains how to use the special functions to overcome these problems.

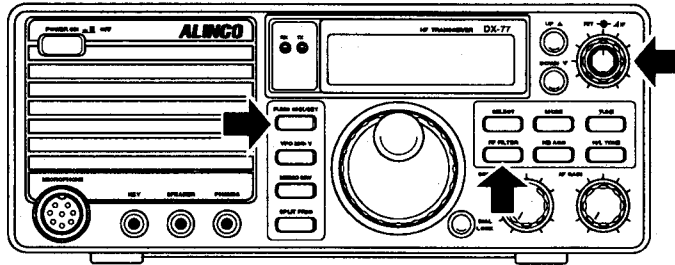

### Reducing Interference

#### Activating IF SHIFT function

- This function eliminates interference by shifting the filter pass band without changing the receive frequency.
1. Turn the  $\Delta$ IF control knob clockwise or counterclockwise to reduce interference.

#### Using the filter

- Using the narrow filter in conjunction with the **IF SHIFT** function will effectively eliminate interference.

Selecting **CWL** or **CWU** mode automatically engages the **CW** filter, and **NAR** appears on the **LCD**. To disengage the **CW** filter, press the **FUNC** key then press **FILTER** key. An audio 500 Hz **CW** filter is standard the all DX-77. The I.F. 500 Hz **CW** filter EJ-35U is standard for DX-77T and optional for DX-77E.

#### Activating BFO REVERSE function

1. Select the **CWU** or **CWL** mode.
  - If your station and the other station are zeroed-in, this function will not change the receive tone and transmit frequency.

#### 4. Activating the RF attenuator

- The attenuator can protect the received signal from suppression and cross-modulation caused by neighboring signals.

---

## Communicating in Bad Conditions

---

### Activating the RF preamplifier

- Press the **RF** key repeatedly until  appears.

The preamplifier will come on.

---

## When the received signal is unclear

---

When the other station calls back to you with a slight offset, you may receive an unclear signal. In this case, perform the following.

### Activating the RIT function

- Rotate the **RIT** control knob to adjust your receive frequency.
  - The **RIT** operation does not change your transmit frequency so that the other station does not need to shift his receive frequency.

---

## Communicating in Pile-ups

---

### Selecting the FULL BREAK-IN mode

- In this mode, keying will transmit and un-keying will receive automatically. This allows you to call with perfect timing.
- Select the **FULL** break-in mode in the **SET** mode (see page 6-5).



## 2.11 RTTY PACKET OPERATION (FAX/SSTV)

### Introduction

This transceiver has no dedicated mode for RTTY packet, FAX, and SSTV operations. However, these operations can be enabled by using the following procedures.

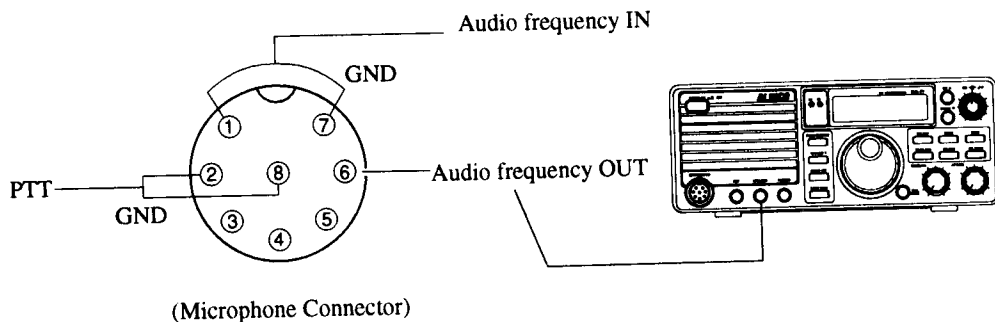

### Connecting Additional Equipment

- Pin (1) — To audio output of additional equipment.
- Pin (7) — To ground of the audio output.
- Pin (2) — To PTT output of additional equipment.
- Pin (6) (unsquenced detector output, 5 K $\Omega$  0.5V P-P) or external speaker jack — To RECEIVE SIGNAL.AF-IN.
- Pin (8) — To PTT GND of additional equipment

### Procedure

1. Turn the power on.
2. Select the mode.
3. Select the desired operating band.
4. Start receiving.

	Mode commonly used
RTTY (AFSK)	LSB
AFSK (300 baud)	SSB
AFSK (1200 baud)	FM
FAX	SSB/FM
SSTV	SSB/FM

## 2.12 SPLIT-FREQUENCY OPERATION

### Introduction

When communicating with a DX (long distance) station that is using a different operating band or is involved in a pile-up, they may be using one **VFO** for the receive frequency, and the other **VFO** for the transmit frequency. This is called **SPLIT** operation. To facilitate this operation, you can activate the **QUICK OFFSET** function (page 3-5) as well as the function that allows you receive and to check the transmit frequency.

 *Tip: Pile-up — the condition where many stations call one station at the same time.*

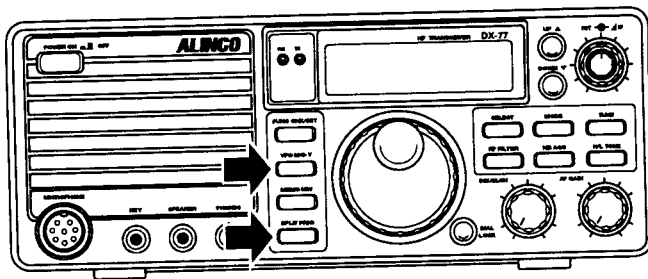

### Procedure

Example: Setting the receive frequency to 7.270 MHz and the transmit frequency to 7.070 MHz (This is example only: 7.070 MHz (or 7.270 MHz) may not be allowed for SSB operation in some countries.)

1. Set the desired transmit frequency in the **VFO B**.

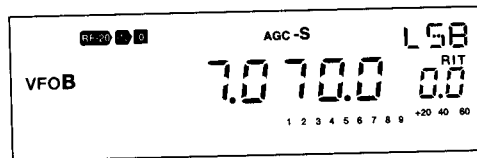

2. Press the **VFO** key to select the **VFO A**. Then set the receive frequency in the **VFO A**.
3. Press the **SPLIT** key.

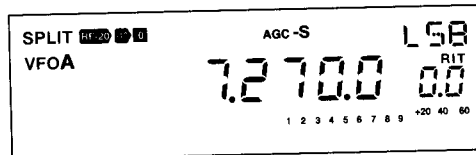

4. Begin communication as usual.

The last displayed VFO (whether **A** or **B**) before pressing the **SPLIT** key becomes the receiving frequency.

- To cancel the split-frequency operation, press the **SPLIT** key again.



*Tips:*

- Pressing and holding the **FUNC** key allows you to monitor the transmit frequency during reception. While monitoring, you can fine-adjust the transmit frequency using the main tuning dial.
- Pressing and holding the **VFO** key longer than one second will transfer memory data from the selected **VFO A** or **B** to the other **VFO B** or **A**. This is useful when setting a split frequency.
- Using the **QUICK OFFSET** function will make it easier to set a split frequency. This function is useful, for example, when the other station requires you to shift the current frequency upwards by 20 kHz or downwards by 30 kHz. This is also useful in repeater operation knowing a predetermined offset frequency. (page 3-5)

# Chapter 3 Memory Features

## 3.1 BASICS

---

### Introduction

This transceiver can store 100 channels in memory. Each can retain different operating data such as receive and transmit frequencies. It is useful to store regularly used frequencies in the memory.

---

### Features

#### Storable Data

These items can be stored in any memory channel "00" through "99."

- Transmit/receive frequency (including split frequency)
- Mode (**SSB**, **CW**, **FM**, **AM**, etc.)
- Filter (standard/narrow, not applicable in the **SSB**, **FM** mode)
- **RF** (preamplifier/attenuator)
- **AGC** (slow/fast, not applicable in the **FM** mode)
- **NB** (ON/OFF)
- Tone (ON/OFF, for **FM** mode only)
- **SPLIT** (ON/OFF)

#### Functions in the **MEMORY** mode

- Memory frequency access protection (see page 6-14)
- Memory overwrite protection (see page 6-13)
- Memory-VFO transfer (see page 3-9)

#### Memory backup

This transceiver uses an EEPROM for memory which can retain data in the memory channels for an extended period without a backup battery.

## 3.2 MEMORY MODE OPERATION

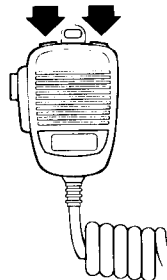
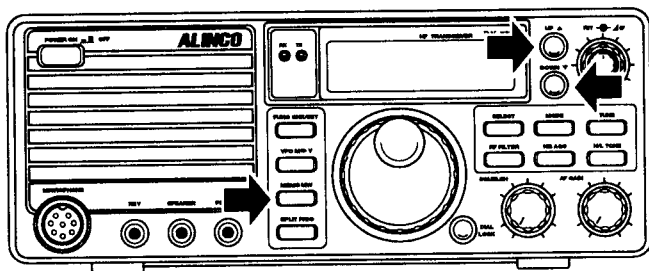

### Procedure

**Accessing the Memory Mode** (For programming the Memories, see following pages.)

1. Press the **MEMO** key.

The last-used memory channel will be recalled.

Memory channel will not appear if nothing has been programmed in the memory.

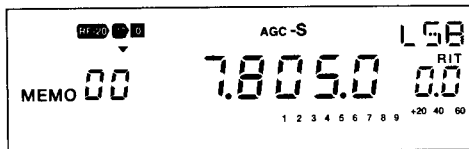

### Selecting a memory channel

2. Press the **UP/DOWN** keys (or the **UP/DOWN** keys of the microphone) to select the desired memory channel.



- Unprogrammed memory channels will be skipped.
- You can temporarily change the frequency, mode, **RIT** function, etc. in a recalled memory channel. However, next time you select that memory channel, the data originally stored will be recalled.
- In the **SET** mode, you can protect all memory channels from having their frequencies changed. (page 6-13)

## 3.3 SIMPLEX-VFO-FREQUENCY PROGRAMMING

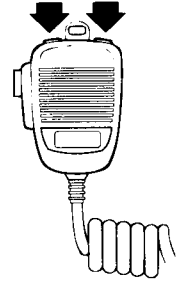
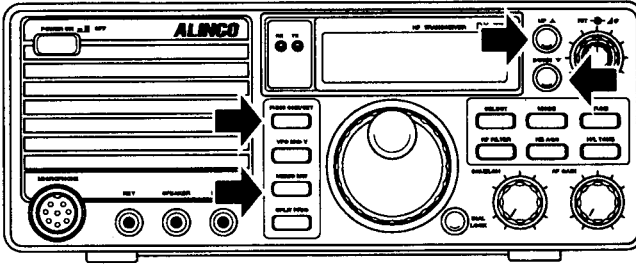

### Procedure

Example: Storing 7.050.0 MHz and **LSB** into memory channel "88"

#### Setting data

1. Set the data to be stored.

#### Selecting a memory channel

2. Press the **FUNC** key.

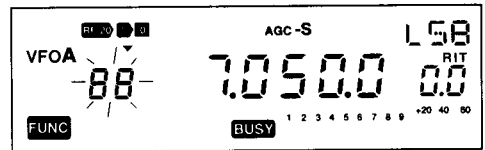

3. Press the **UP/DOWN** keys (or the **UP/DOWN** keys of the microphone) to select memory channel "88."

Numbers of already programmed channels will be continuously displaying, and of unprogrammed channels will be flashing.

#### Storing data

4. Press the **MEMO** key.



*Note: If there is no key entry within 5 seconds after **FUNC** appears, the function will be canceled.*

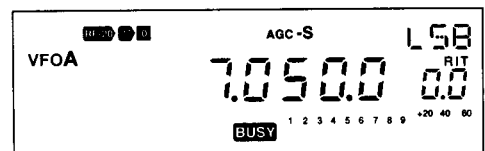

*Note: Pressing the **MEMO** key will overwrite any previous data in that channel with new data, unless protected (page 6-13).*

# 3.4 SIMPLEX-MEMORY-FREQUENCY PROGRAMMING

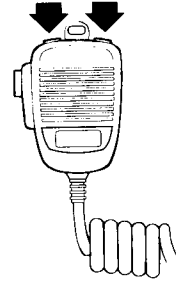
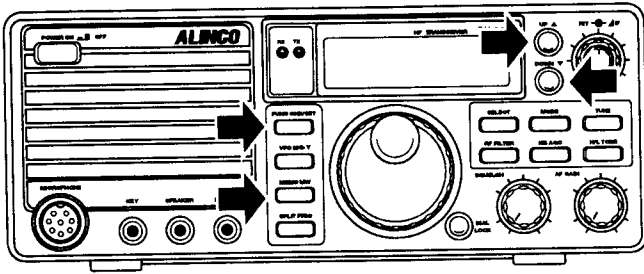

## Procedure

Example: Copying data in memory channel "88" into memory channel "73"

### Setting data

1. Select memory channel "88" (programmed).

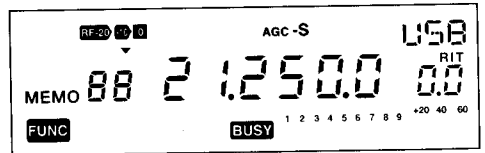

### Selecting a memory channel

2. Press the **FUNC** key.
3. Press the **UP/DOWN** keys (or the **UP/DOWN** keys of the microphone) to select memory channel "73."

The programmed channel number will be continuously displaying, and the unprogrammed memory channel number will be flashing.

### Storing data

4. Press the **MEMO** key.

**Note:** If there is no key entry within 5 seconds after **FUNC** appears, the function will be canceled.

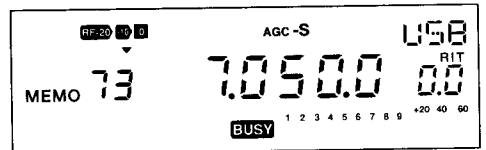

**Note:** Pressing the **MEMO** key will overwrite any previous data in that channel with new data.

- Tips:**
- This function is useful when you want to store the current frequencies and settings into a selected memory channel.
  - In the **SET** mode, you can protect all memory channels from overwriting. (page 6-13)

## 3.5 SPLIT-FREQUENCY PROGRAMMING (FOR GENERAL USE) USING QUICK OFFSET FUNCTION

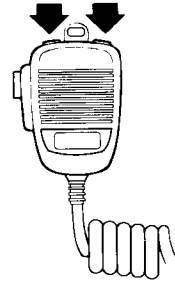
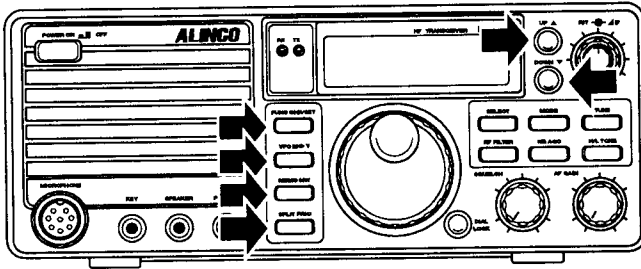

### Procedure

Example: Storing 14.275.0 MHz (transmit frequency) and 14.250.0 MHz (receive frequency) into memory channel "59"

#### Setting data

1. Set 14.250 MHz (receive frequency) in either **VFO A** or **VFO B**.

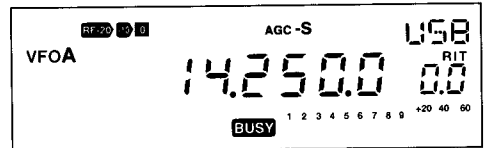

2. Press and hold the **SPLIT** key until "0.000.0" is displayed and, with the key down, rotate the main tuning dial to select + 25.0 kHz.

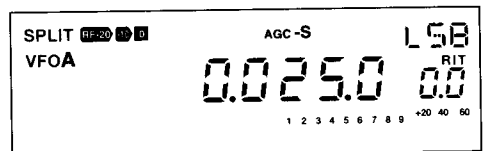

⇒ *QUICK OFFSET function, page 2-23*

#### Selecting a memory channel

3. Press the **FUNC** key.
4. Press the **UP/DOWN** keys (or press the **UP/DOWN** keys of the microphone) to select memory channel "59."

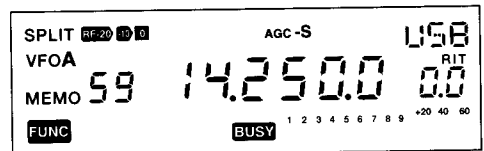

#### Storing data

5. Press the **MEMO** key.



*Note: If there is no key entry within 5 seconds after **FUNC** appears, the function will be canceled.*

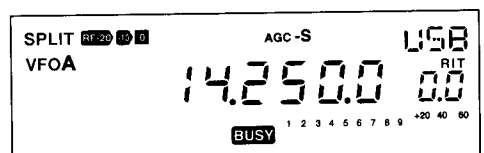



# 3.6 SPLIT-FREQUENCY PROGRAMMING (FOR REPEATER OPERATION)

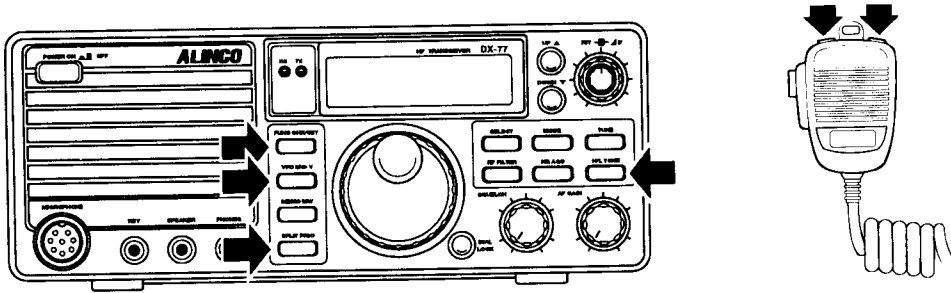



## Procedure

Example: Storing 29.540.0 MHz (transmit frequency) and 29.640.0 MHz (receive frequency) into memory channel "03"

### Setting data

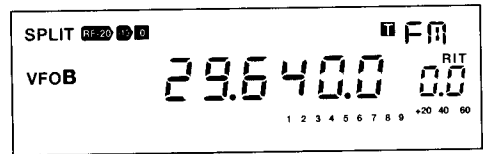
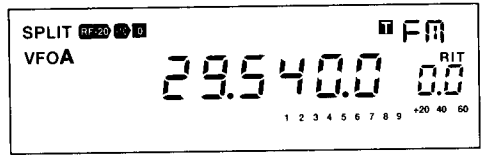
1. Set 29.540.0 MHz (transmit frequency) in the **VFO A**.
  - Also set **FM** and if applicable "ON" in CTCSS tone "**T**" in the same channel.
2. Set 29.640.0 MHz (receive frequency) in the **VFO B**.



 *Tip: The **VFO A=B** function is useful prior to setting split frequencies.*

3. Press the **SPLIT** key.

(continued to next page)

## Selecting a memory channel

4. Press the **FUNC** key.
  - Press the **FUNC** key while the receive frequency is displayed. The frequency shown in step 2 is the receive frequency.
5. Press the **UP/DOWN** keys (or press the **UP/DOWN** keys of the microphone) to select memory channel "03."

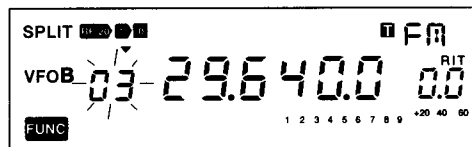

## Storing data

6. Press the **MEMO** key.



*Note: If there is no key entry within 5 seconds after **FUNC** appears, the function will be canceled.*

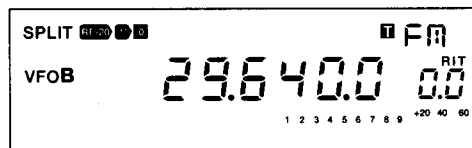

## 3.7 MEMORY CHANNEL DATA ERASING

### Erasing Data in a Selected Memory Channel

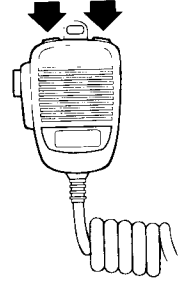
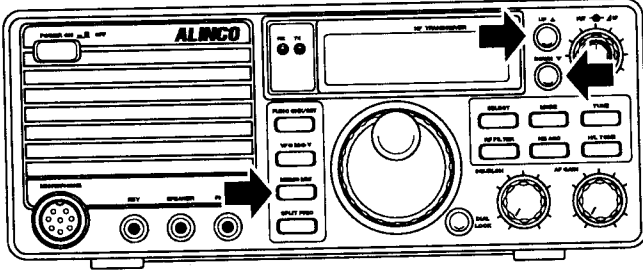

1. Press the **MEMO** key to access the **MEMORY** mode.
2. Press the **UP/DOWN** keys or press the **UP/DOWN** keys of the microphone to select a memory channel that contains data you want to erase.

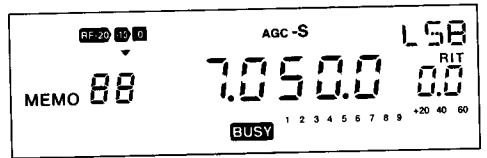

3. Press and hold the **MEMO** key.

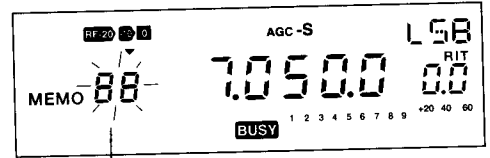

Flashing

4. Release the key when hearing a beep and the memory channel number starts flashing.

**⚠ Note:** Releasing the key will not affect the current LCD indication, but will erase the data in the selected memory channel.

### Erasing All Memory Channels

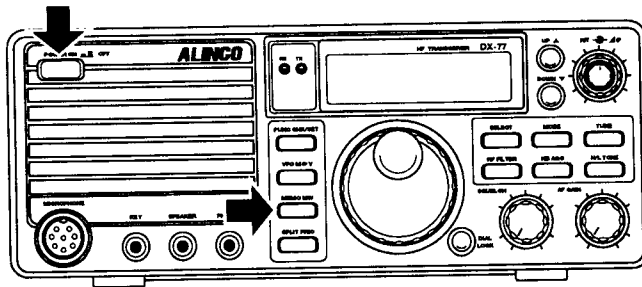

1. While holding down the **MEMO** key, turn the power on.

## 3.8 MEMORY TO VFO DATA TRANSFER

### Introduction

This function can transfer data from any memory channel to the **VFO**. This is useful when you want to tune in a station near the frequency stored in a memory channel.

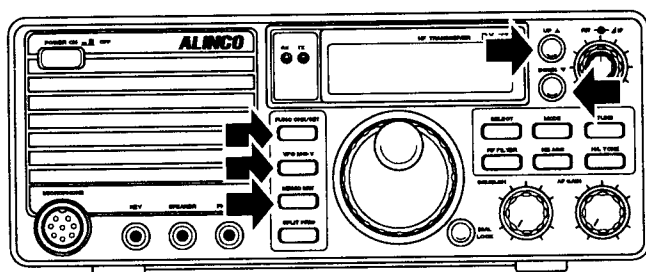

### Procedure

Example: Transferring data in memory channel "06" into the **VFO A**

1. Select the **VFO A**.
2. Press the **MEMO** key.
3. Press the **UP/DOWN** keys or press the **UP/DOWN** keys of the microphone to select memory channel "06."



4. Press the **FUNC** key, then press the **VFO(M→V)** key.

 *Note: If there is no key entry within 5 seconds after **FUNC** appears, the function will be canceled.*

5. Press the **VFO(M→V)** key again.

 *Note: After transfer, the original data still remains in the memory channel.*

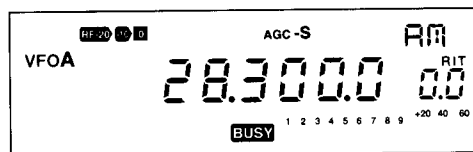

# Chapter 4 Scanning

## 4.1 BASICS

### Introduction

Scanning lets you automatically search for signals across a specific frequency range or among programmed memory channels. There are three types of scans; band, memory, and priority.

### Scan Types

#### Band scan

This scan searches the entire frequency range of the amateur band in user-specified steps.

Band	Range	Step
1.8	1.8000 - 1.9999MHz	Frequency steps are set according to mode. Default settings are as follows:  SSB, CW: 1.0 kHz AM: 1.0 kHz FM: 2.5 kHz (See pages 6-10, 11 or 12 to set frequency steps.)
3.5	3.5000 - 3.9999MHz	
7	7.0000 - 7.2999MHz	
10	10.1000 - 10.1499MHz	
14	14.0000 - 14.3499MHz	
18	18.0680 - 18.1679MHz	
21	21.0000 - 21.4499MHz	
24	24.8900 - 24.9899MHz	
28	28.0000 - 28.9999MHz	
	29.0000 - 29.6999MHz	

- When the general coverage receiver is activated, this scan also searches for signals *between* the amateur bands. For example, if the starting frequency is the scan searches for signals between 4.0000 MHz-6.9999 MHz.

The following diagram shows how signals are scanned, depending on the frequency where the scan is started.

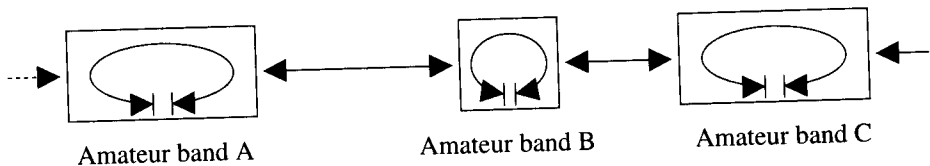

## Memory scan

- This scan searches for signals in programmed memory channels in numerical order.
- Unprogrammed memory channels will be skipped.
- The 100 memory channels are grouped into 10 channels (00~09, 10~19, 20~29, . . . , 90~99). The transceiver scans only memory channels belonging to the group you specified. This is called “group memory scan.” The group memory scan can be set to on or off in the **SET** mode (see page 6-16).

### Memory scan

The transceiver scans only programmed channels. Pressing the microphone's **UP** key will scan upwards and pressing the **DOWN** key will scan downwards through the channels.

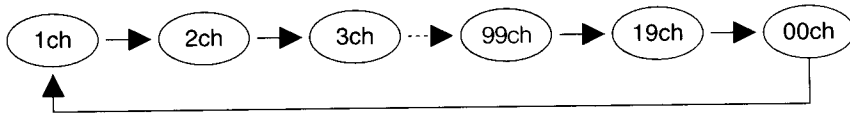

### Group memory scan

The transceiver scans only memory channels belonging to the group you specified.

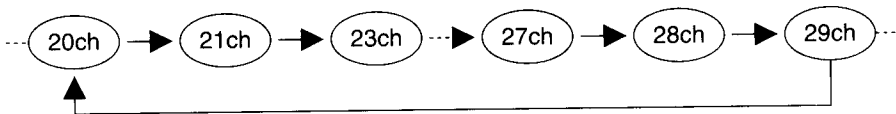

## Priority Scan

- The transceiver receives signals on a **VFO** or memory channel for 5 seconds, and then scans a memory or **VFO** you specified for 0.5 seconds (2 seconds if squelch is unmuted).
- This function is usually used in split-frequency operation between the **VFO A/B** and a memory channel.

	Display frequency (5 seconds)	Priority frequency (0.5 seconds)
VFO A priority	VFO A	Memory
VFO B priority	VFO B	Memory
Memory priority A	Memory	VFO A
Memory priority B	Memory	VFO B

## Setting SCAN Mode

### SCAN modes

Each **SCAN** mode has specific condition for stopping and resuming scanning. You can select one of the **SCAN** modes listed below. (Signal detection is defined by squelch unmuting. Therefore the squelch should be set to threshold.)

LCD	SCAN mode
OF	Stops scanning when a signal is picked up, and quits scanning.
00	Stops scanning when a signal is picked up, and will resume scanning after the signal is dropped.
0	Will not stop scanning even when signals are picked up.
2	Stops scanning when a signal is picked up, and will resume scanning after 2 seconds.
4	Stops scanning when a signal is picked up, and will resume scanning after 4 seconds.
6	Stops scanning when a signal is picked up, and will resume scanning after 6 seconds.

### Procedure

1. Press the **FUNC** key, then press and hold the **FUNC** key down longer than 2 seconds.
2. Press the **SPLIT** key repeatedly until "SCAN" appears on the LCD.

 *Note: If there is no key entry within 5 seconds after **FUNC** appears, the function will be canceled.*

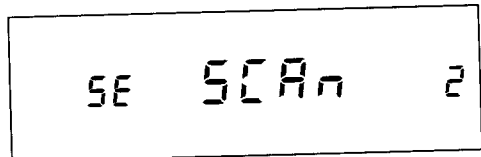

3. Press the **UP/DOWN** keys to select one of the above **SCAN** modes.

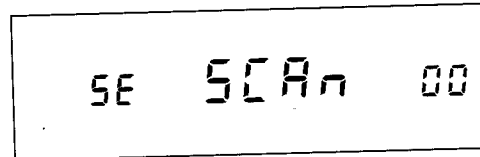

4. Press the **FUNC** key.

 *Note: The default is "2," meaning that the scan pauses when a signal is received and will resume after 2 seconds.  
The **TUNE** key must be used after canceling the scan mode.*

## 4.2 BAND SCAN

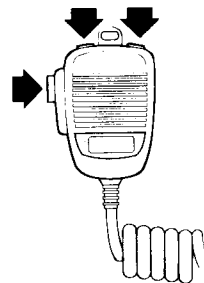
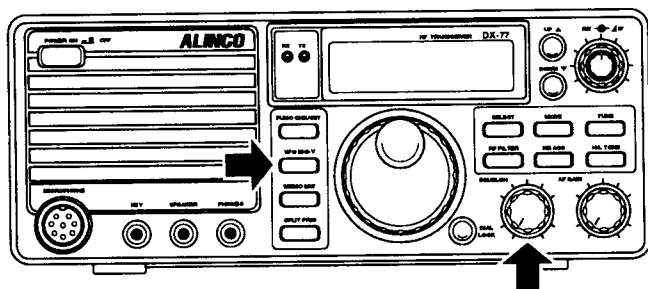

### Procedure

1. Press the **VFO** key to access the **VFO** mode.
2. Select the desired band.
3. Select the desired mode.
4. Erase ▼ with the **SELECT** key, if it is on the LCD.
5. Rotate the **SQL** control knob to just mute the audio.
6. Hold the microphone's **UP/DOWN** keys down longer than 2 seconds.

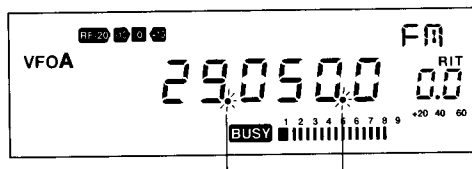

Flash while scanning is in progress.

The scan will start.

- Pressing the **UP** key will scan upwards, and pressing the **DOWN** key will scan downwards across the band.



- Notes:**
- In the **SSB** or **CW** mode, the scan is not likely to pause at a frequency where the received sound is clear. By setting the resumption time long enough, you can fine-tune the frequency using the **RIT** control knob while the scan pauses.
  - The scan proceeds to the upper limit of the band and returns to the lower limit of the band, or vice versa.

7. To cancel the scan, press the **UP/DOWN** or **PTT** key.



**Tip:** Set the frequency step according to the band used. For example, select a 10 kHz step for 29 MHz FM band.



## 4.3 MEMORY SCAN

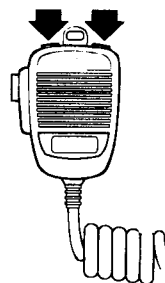
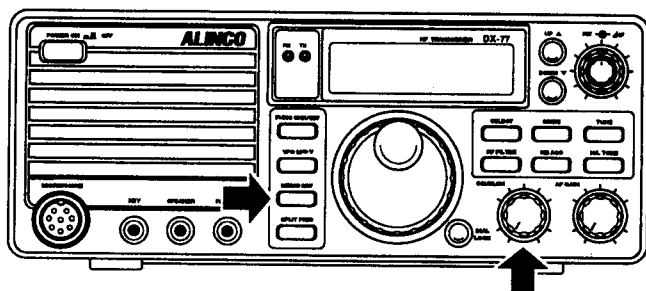

### Procedure

1. Press the **MEMO** key to access the **MEMORY** mode.
2. Rotate the **SQL** control knob to just mute the audio.



*Note: If squelch is unmuted, the scan will pause on each programmed memory channel.*

3. For group memory scan, press the **UP/DOWN** keys to select a memory channel belonging to the group you want to scan.
4. Hold the microphone's **UP/DOWN** keys down longer than 2 seconds.

The scan will start.

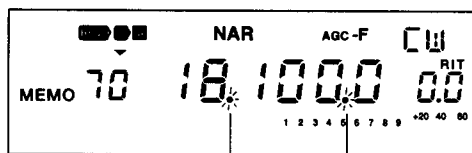

Flash while scanning is in progress.

- Pressing the **UP** key will scan upwards, and pressing the **DOWN** key will scan downwards through memory.
5. To cancel the scan, press the **UP/DOWN** key or **PTT** key.



*Notes:*

- *The scan proceeds to the upper limit and returns to the lower limit of the group (memory channels) or vice versa. Unprogrammed channels will be skipped.*
- *While scanning is in progress, the RIT control knob is still operatable.*

# 4.4 PRIORITY SCAN

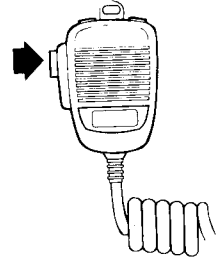
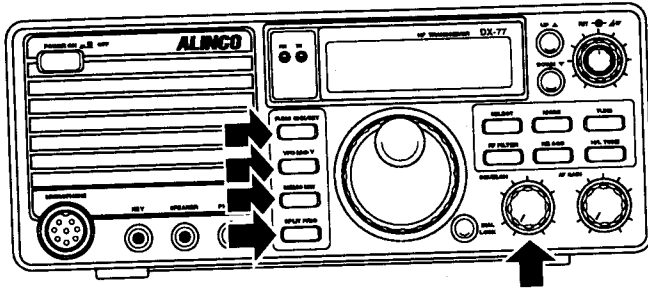

## Procedure

Example: Receiving in the **VFO A** mode and momentarily scanning a memory channel (priority channel)

1. Access the **MEMORY** mode and select the memory channel you want to scan momentarily.

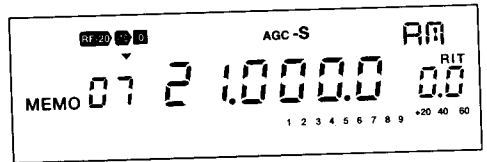

2. Access the **VFO** mode and set the frequency you usually receive.
3. Rotate the **SQL** control knob to adjust squelch level.

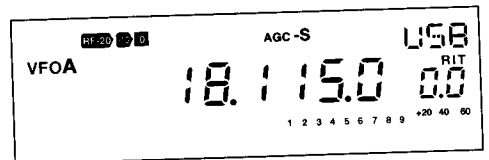

4. Press the **FUNC** key, then press the **SPLIT(PRIO)** key.

**Note:** If there is no key entry within 5 seconds after **FUNC** appears, the function will be canceled.

The transceiver will receive the **VFO** for 5 seconds and then will check the memory channel for 0.5 seconds (2 seconds when squelch is unmuted).

- The **SCAN** mode can be selected in the **SET** mode.
5. To exit from this mode, press the **FUNC** key, then press the **SPLIT(PRIO)** or press **PTT** key when on the priority channel.

**Note:** If there is no key entry within 5 seconds after **FUNC** appears, the function will be canceled.

# Chapter 5 Special Functions

## 5.1 INTERFERENCE REDUCERS

### Introduction

This transceiver has built-in functions to reduce interferences. This section explains how to use these functions to reduce interference.

### IF SHIFT

The **IF SHIFT** function is used to shift the IF pass band without changing the receive frequency. If there is an interference signal near the received signal, rotate the  $\Delta$ IF control knob to get the interference signal out of the receive band.

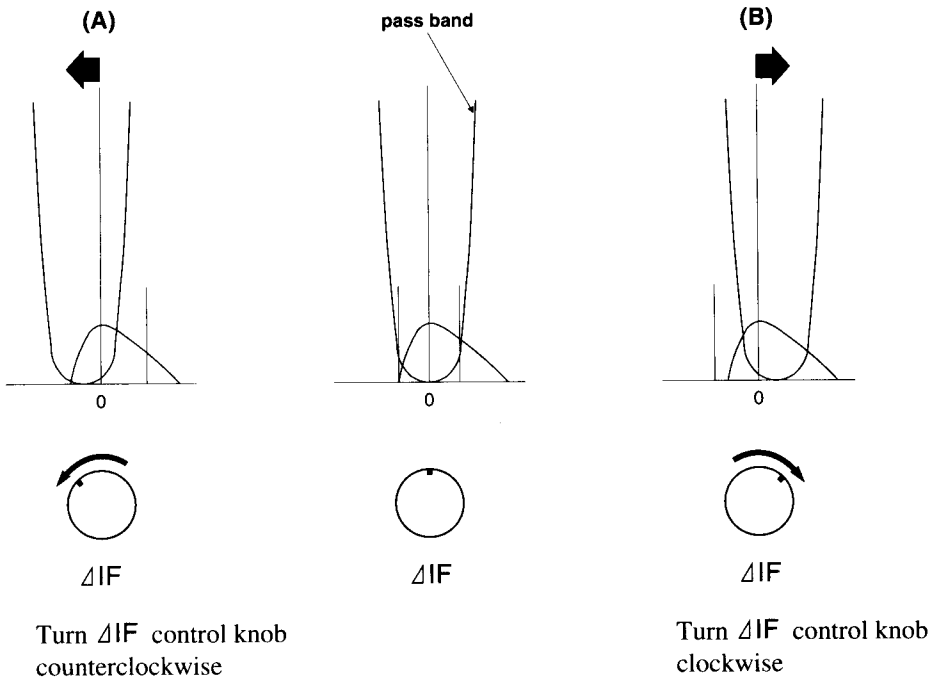

- Notes:**
- This function can shift the IF pass band within a range of only  $\pm 1.5$  kHz.
  - This function will be disabled in the **AM** and **FM** modes.



**Tip:** This function can also be used to adjust the audio quality.

## Narrow Filter

The narrow filter can be used in each mode except the **SSB, FM** mode. This allows you to effectively reduce interference.

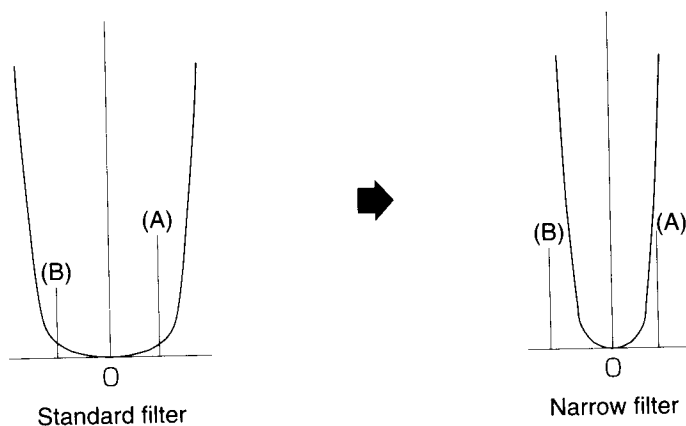

- If there are interference signals (A) and (B) when the standard filter is used, using the narrow filter will reduce the interference.

 **Notes:** Using the narrow filter will change audio quality.

- Filter bandwidth

	Standard	Narrow
CW	2.7	0.5* (OPTION)
SSB	2.7	—
AM	8	2.7
FM	8	

1. Press the **FILTER** key to select a filter.
  - Press the **FUNC** key then press the **FILTER** key to select a filter.
  - To clarify the received signal, use the  $\Delta$ IF function together.

\* An audio **CW** filter comes standard for all DX-77 and the I.F. filter EJ-35U is optional. The EJ-35U is installed as standard for DX-77T.

## CW BFO REVERSE

The **CW** mode has **CWU** (upper sideband) and **CWL** (lower sideband) options. Selecting the **CWU** or **CWL** can help reduce interference.

When your receive frequency is zeroed-in with the other station's transmit frequency, this function would not affect the receive tone or transmit frequency.

1. Press the **MODE** switch to select the **CWU** or **CWL** mode.

(A) Desired signal  
(B) Interference signal  
(C) Reception pitch

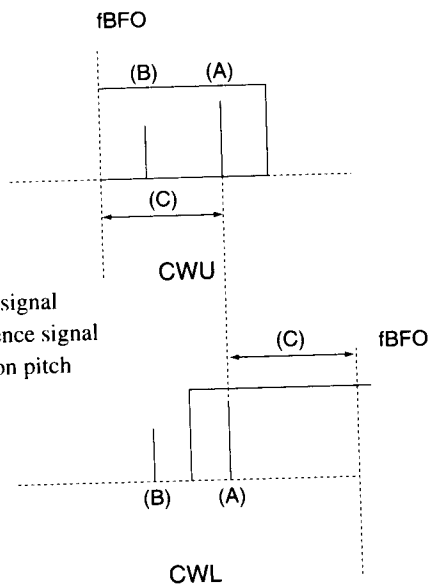

## NB (Noise Blanker)

The noise blanker suppresses pulse noise like that from car ignition to clarify the received signal.

1. Press the **NB** key.

The "NB" icon will be displayed.

## ATT (Attenuator)

This function is used to reduce the receiver's front-end gain when you receive very strong signals or interference signals.

- Press the **RF** key to select the receiver's front-end gain setting.

**RF 20 10**

A -10 dB attenuator is activated.

**RF 20**

A -20 dB attenuator is activated.

## 5.2 OTHER USEFUL FUNCTIONS

### RIT Function

#### RIT function

The **RIT** function is used to change the receive frequency within a range of  $\pm 1.0$  kHz.

 *Tip: This function is useful when the other station is off frequency.*

#### Procedure

1. Rotate the **RIT** control knob to adjust the receive/transmit frequency.

Displays the **RIT** shift frequency.

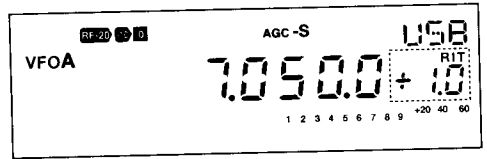

 *Note: If you use the main tuning dial to tune in the frequency with the RIT knob not at the center, the transmit and receive frequency will be different.*

## VFO A=B

This function transfers data in the **VFO A** to the **VFO B**, and vice versa.

 *Tip: This function will be useful when you want to keep the current frequency and settings in one **VFO**, and use or change them in the other **VFO**. You may also use this function when setting split frequencies.*

### Procedure

1. Set the **VFO** on the frequency desired.

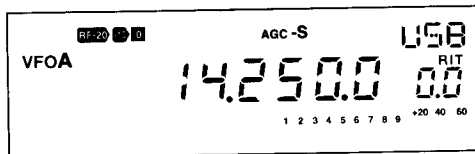

2. Hold the **VFO** key down longer than one second.

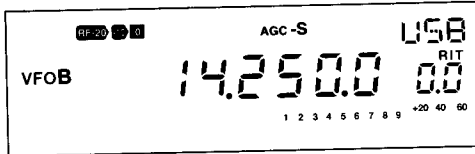

- Now see sure that the **VFO A** and **VFO B** have the same data.

## DIAL LOCK Function

This function locks the main tuning dial to prevent accidental frequency changes.

*Tip:* This function is useful in mobile operation where the main tuning dial may be rotated by car vibrations, etc. While this function is activated, tuning is still possible with the **UP/DOWN** key and **RIT** control knob.

### Procedure

1. Press the **DIAL LOCK** key.

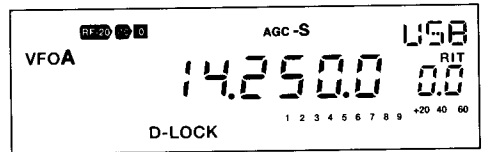
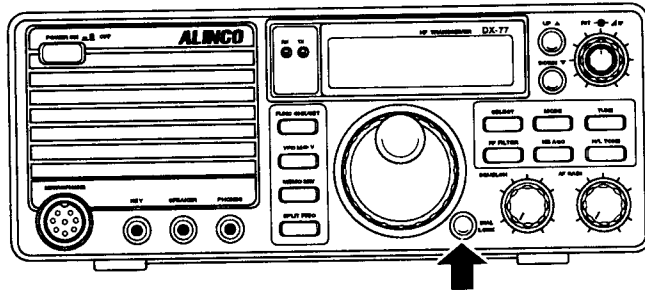

- To cancel this function, press the **DIAL LOCK** key again.



# Chapter 6 Set-Up

## 6.1 SET MODE

---

### Introduction

---

The chapter explains the set-up items and procedures in the **SET** mode. This mode is not frequently accessed, but by customizing each function, you can operate this transceiver more effectively and conveniently.

### Set-up Item List

---

- Sidetone and **CW** offset setting
- LCD brightness
- Transmission inhibit (**PTT** key lock)
- Memory overwrite protection
- Memory frequency access inhibit
- Group memory scan
- Automatic **USB/LSB** selection
- Break-in delay time
- Beep
- Speech compressor
- Frequency step of the **UP/DOWN** key
- Scan mode

## Basic Procedure

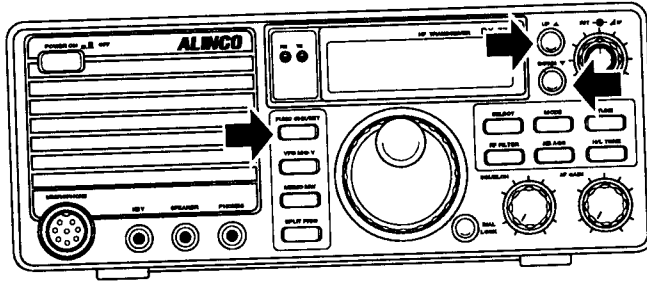

1. Press the **FUNC** key

**FUNC** will appear.

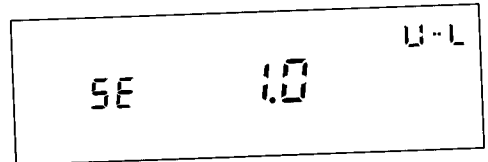

2. Press again and hold the **FUNC** key down longer than 2 seconds.

"SE" will appear, indicating the transceiver is in the **SET** mode.

3. Press the key for the function you want to set up.

 **Note:** If there is no key entry within 5 seconds after **FUNC** appears, the function will be canceled.

4. Press the **UP/DOWN** keys to select the desired option.

5. Press the **FUNC** key to confirm the selection and exit from the **SET** mode.

## 6.2 SET-UP ITEMS

### Automatic USB/LSB Selection

#### Description

This function automatically selects the **USB** or **LSB** mode depending on which amateur band has been selected in **SSB** mode. If "OF"(OFF) is selected, the last-used **SSB** mode is recalled when you access the **SSB** mode.

#### Options

- "On"                      ■ "OF" (OFF)

(The default is "On")

#### Procedure

1. Press the **FUNC** key.
2. Press again and hold the **FUNC** key down longer than 2 seconds to access the **SET** mode.
3. Press the **MODE** key.

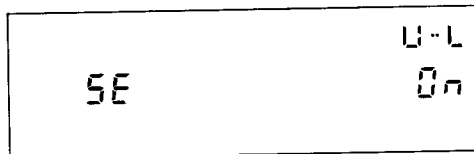

4. Press the **UP/DOWN** keys to select "On" or "OF."

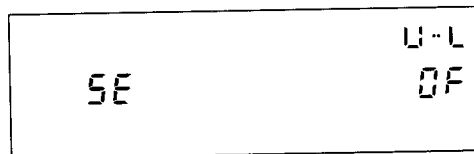

5. Press the **FUNC** key to confirm the selection and exit from the **SET** mode.



*Note: If there is no key entry within 5 seconds after **FUNC** appears, the function will be canceled.*

## Sidetone and CW Offset Setting

### Description

The sidetone will change according to the **CW** offset you select.

### Options

- 400 Hz~1000 Hz 50 Hz step

(The default is "800")

### Procedure

1. Press the **FUNC** key.
2. Press again and hold the **FUNC** key down longer than 2 seconds to access the **SET** mode.
3. Press the **RF** switch.



*Note: If the **BREAK-IN** setting menu (page 6-5) is displayed, press this key again.*

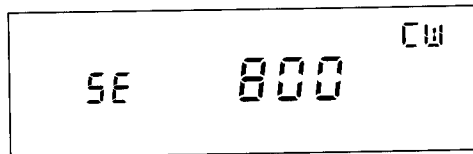

4. Press the **UP/DOWN** keys to select the desired **CW** offset.

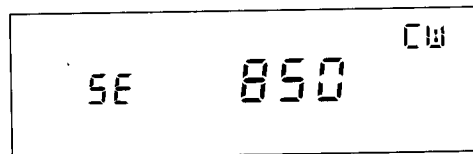

5. Press the **FUNC** key to confirm the selection and exit from the **SET** mode.



*Note: If there is no key entry within 5 seconds after **FUNC** appears, the function will be canceled.*

## Break-in Delay Time

### Description

You can select from **AUTO BREAK-IN**, **SEMI BREAK-IN** (selectable in 7 steps), and **FULL BREAK-IN**.

### Options

- “Auto”                      The delay time for the **SEMI BREAK-IN** mode will be set automatically according to the code speed being transmitted.
- “dLy 1” to “dLy 7”      Select the desired delay time for the **SEMI BREAK-IN** mode (“1” is the shortest, and “7” is the longest).
- “FuLL”                      The **FULL BREAK-IN** mode

(The default is “Auto”)

### Procedure

1. Press the **FUNC** key.
2. Press again and hold the **FUNC** key down longer than 2 seconds to access the **SET** mode.
3. Press the **RF** switch.

 *Note: If the sidetone setting menu is displayed, press this key again.*

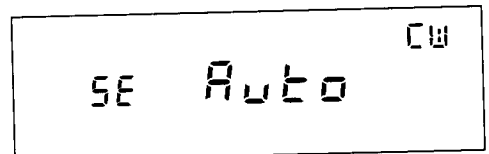

4. Press the **UP/DOWN** keys to select the desired **BREAK-IN** mode.

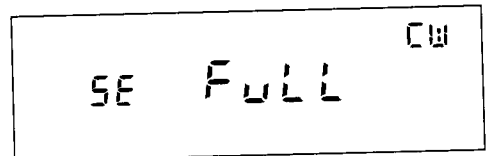

5. Press the **FUNC** key to confirm the selection and exit from the **SET** mode.

 *Note: If there is no key entry within 5 seconds after **FUNC** appears, the function will be canceled.*

## LCD Brightness

### Description

You can change the brightness of the LCD back-light.

### Options

- "0" (OFF)
- "1" to "5"

(The default is "3")

### Procedure

1. Press the **FUNC** key.
2. Press again and hold the **FUNC** key down longer than 2 seconds to access the **SET** mode.
3. Press the **SELECT** key repeatedly until "LP" appears on the LCD.
 

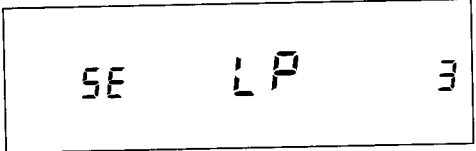
4. Press the **UP/DOWN** keys to select the desired brightness.
 

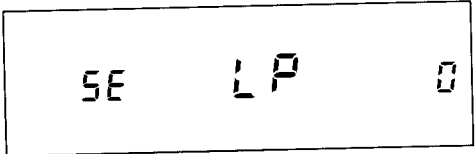
5. Press the **FUNC** key to confirm the selection and exit from the **SET** mode.



*Note: If there is no key entry within 5 seconds after **FUNC** appears, the function will be canceled.*

## Beep

### Description

If “On” is selected, a high-pitch beep will be heard each time a valid key is pressed, and a low-pitch beep will be heard each time an invalid key is pressed.

### Options

- “On”                      ■ “OF” (OFF)

(The default is “On”)

### Procedure

1. Press the **FUNC** key.
2. Press again and hold the **FUNC** key down longer than 2 seconds to access the **SET** mode.
3. Press the **SELECT** key repeatedly until “bEEP” appears on the LCD.

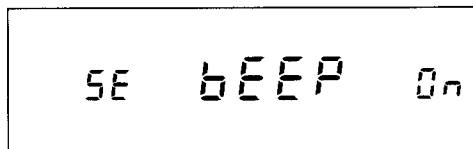

4. Press the **UP/DOWN** keys to select “On” or “OF.”

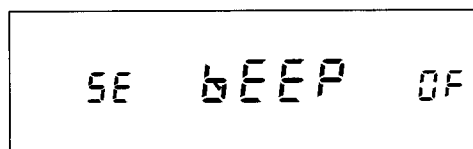

5. Press the **FUNC** key to confirm the selection and exit from the **SET** mode.



*Note: If there is no key entry within 5 seconds after **FUNC** appears, the function will be canceled.*

## Speech Compressor

### Description

The speech compressor increases talk power. This is useful for transmission in the **SSB** and **AM** modes.

### Options

- "On"                      ■ "OF" (OFF)

(The default is "OF")

### Procedure

1. Press the **FUNC** key.
2. Press again and hold the **FUNC** key down longer than 2 seconds to access the **SET** mode.
3. Press the **H/L** key.

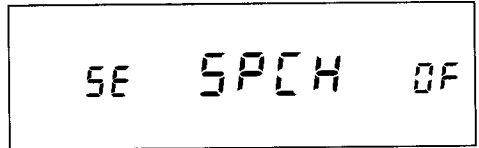

SE SPCH OF

4. Press the **UP/DOWN** keys to select "On" or "OF."

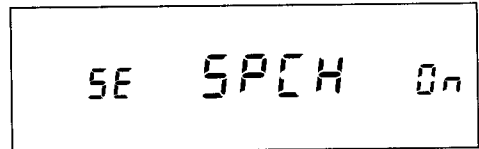

SE SPCH On

5. Press the **FUNC** key to confirm the selection and exit from the **SET** mode.



*Note: If there is no key entry within 5 seconds after **FUNC** appears, the function will be canceled.*



## Transmission Inhibit (PTT Key Lock)

### Description

If "On" is selected, the transceiver can operate only as a receiver.

### Options

- "On"                      ■ "OF" (OFF)

(The default is "OF")

### Procedure

1. Press the **FUNC** key.
2. Press again and hold the **FUNC** key down longer than 2 seconds to access the **SET** mode.
3. Press the **DIAL LOCK** key.

The LCD display shows the text "SE PTT.L OF" in a segmented font, indicating the current menu option is "PTT.L" and the selected mode is "OF".

4. Press the **UP/DOWN** keys to select "On" or "OF."

The LCD display shows the text "SE PTT.L On" in a segmented font, indicating the current menu option is "PTT.L" and the selected mode is "On".

5. Press the **FUNC** key to confirm the selection and exit from the **SET** mode.



*Note: If there is no key entry within 5 seconds after **FUNC** appears, the function will be canceled.*

## Frequency Step of the UP/DOWN Keys (SSB and CW Modes) \_\_\_\_\_

### Description

You can separate **VFO** frequency steps of the **UP/DOWN** keys for the **SSB** and **CW** modes. When you press the **UP/DOWN** keys with no **▼** displayed, the displayed frequency will change in the step selected here.

### Options

- “0.1” (kHz)
- “0.5” (kHz)
- “1.0” (kHz)
- “2.5” (kHz)

(The default is “1.0”)

### Procedure

1. Press the **FUNC** key.
2. Press again and hold the **FUNC** key down longer than 2 seconds to access the **SET** mode.
3. Press the **VFO** key repeatedly until “U..L” appears on the LCD.

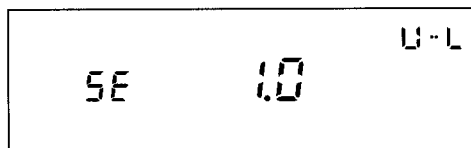

4. Press the **UP/DOWN** keys to select the desired frequency step.

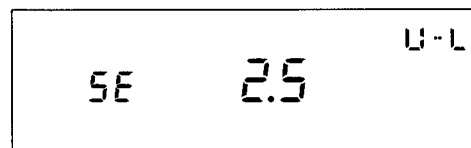

5. Press the **FUNC** key to confirm the selection and exit from the **SET** mode.



*Note: If there is no key entry within 5 seconds after **FUNC** appears, the function will be canceled.*

## Frequency Step of the UP/DOWN Keys (AM mode)

### Description

You can set the specific **VFO** frequency step of the **UP/DOWN** keys for the **AM** mode. When you press the **UP/DOWN** keys with no ▼ displayed, the displayed frequency will change in the step selected here.

### Options

- "1.0" (kHz)
- "2.5" (kHz)
- "5.0" (kHz)
- "9.0" (kHz)
- "10.0" (kHz)

(The default is "1.0")

### Procedure

1. Press the **FUNC** key.
2. Press again and hold the **FUNC** key down longer than 2 seconds to access the **SET** mode.
3. Press the **VFO** key repeatedly until "AM" appears on the LCD.

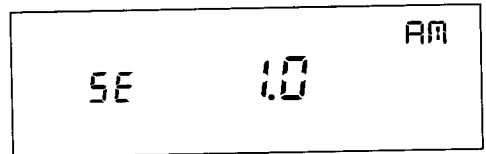

4. Press the **UP/DOWN** keys to select the desired frequency step.

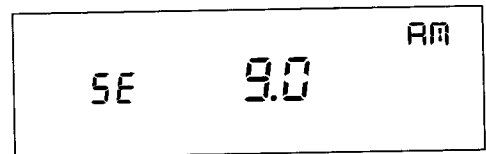

5. Press the **FUNC** key to confirm the selection and exit from the **SET** mode.



*Note: If there is no key entry within 5 seconds after **FUNC** appears, the function will be canceled.*

## Frequency Step of the UP/DOWN Keys (FM mode)

### Description

You can set the specific **VFO** frequency step of the **UP/DOWN** keys for the **FM** mode. When you press the **UP/DOWN** keys with no **▼** displayed, the displayed frequency will change in the step selected here.

### Options

- "2.5" (kHz)    ■ "5.0" (kHz)    ■ "10.0" (kHz)    ■ "12.5" (kHz)
- "20.0" (kHz)    (The default is "2.5")

### Procedure

1. Press the **FUNC** key.
2. Press again and hold the **FUNC** key down longer than 2 seconds to access the **SET** mode.
3. Press the **VFO** key repeatedly until "FM" appears on the LCD.

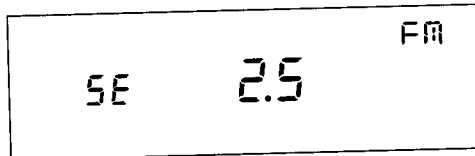

4. Press the **UP/DOWN** keys to select the desired frequency step.

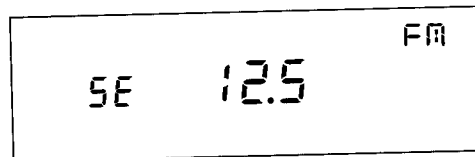

5. Press the **FUNC** key to confirm the selection and exit from the **SET** mode.



*Note: If there is no key entry within 5 seconds after **FUNC** appears, the function will be canceled.*

---

## Memory Overwrite Protection

### Description

This function protects all memory channels from overwrite.

### Options

- “On”
- “OF” (OFF)

(The default is “OF”)

### Procedure

1. Press the **FUNC** key.
2. Press again and hold the **FUNC** key down longer than 2 seconds to access the **SET** mode.
3. Press the **MEMO** key repeatedly until “Prot” appears on the LCD.

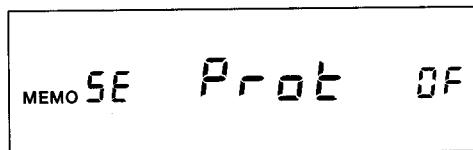

4. Press the **UP/DOWN** keys to select “On” or “OF.”

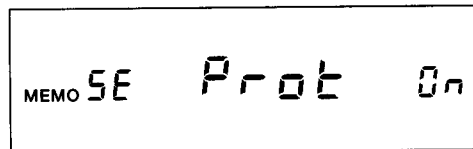

5. Press the **FUNC** key to confirm the selection and exit from the **SET** mode.

 **Note:** If there is no key entry within 5 seconds after **FUNC** appears, the function will be canceled.

## Memory Frequency Access Protection

### Description

This function inhibits temporary change of frequencies on all memory channels. While this function is activated, however, you can still temporarily use the **RIT**, mode, **RF** gain or other setting in the selected channel.

### Options

- "On"                      ■ "OF" (OFF)

(The default is "On")

### Procedure

1. Press the **FUNC** key.
2. Press again and hold the **FUNC** key down longer than 2 seconds to access the **SET** mode.
3. Press the **MEMO** key repeatedly until "FrEq" appears on the LCD.

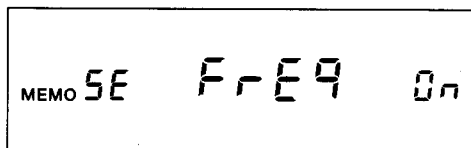

4. Press the **UP/DOWN** keys to select "On" or "OF."

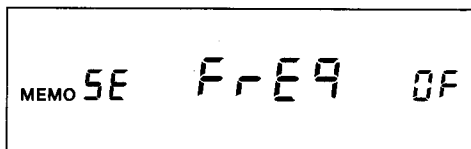

5. Press the **FUNC** key to confirm the selection and exit from the **SET** mode.



*Note: If there is no key entry within 5 seconds after **FUNC** appears, the function will be canceled.*

## SCAN Mode

### Description

You can select a condition for stopping and resuming scanning.

### Options

- "OF" (OFF) Stops scanning when a signal is picked up, and quits scanning.
- "00" Stops scanning when a signal is picked up, and will resume scanning after the signal is dropped.
- "0" Will not stop scanning even when signals are picked up.
- "2" Stops scanning when a signal is picked up, and will resume scanning after 2 seconds.
- "4" Stops scanning when a signal is picked up, and will resume scanning after 4 seconds.
- "6" Stops scanning when a signal is picked up, and will resume scanning after 6 seconds.

(The default is "2")

### Procedure

1. Press the **FUNC** key.
2. Press again and hold the **FUNC** key down longer than 2 seconds to access the **SET** mode.
3. Press the **SPLIT** key repeatedly until "SCAN" appears on the LCD.

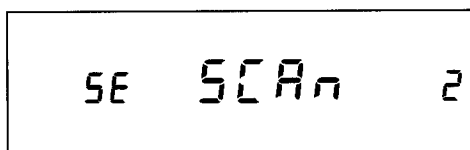

4. Press the **UP/DOWN** keys to select the desired **SCAN** mode.

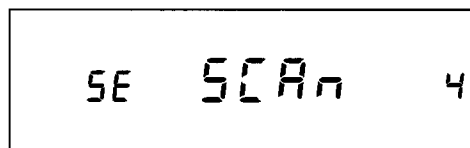

5. Press the **FUNC** key to confirm the selection and exit from the **SET** mode.



*Note: If there is no key entry within 5 seconds after **FUNC** appears, the function will be canceled.*

## Group Memory Scan

### Description

If “On” is selected, the transceiver scans only memory channels belonging to a group of channels that you specified.

### Options

- “On”                      ■ “OF” (OFF)

(The default is “OF”)

### Procedure

1. Press the **FUNC** key.
2. Press again and hold the **FUNC** key down longer than 2 seconds to access the **SET** mode.
3. Press the **SPLIT** key repeatedly until “group” appears on the LCD.

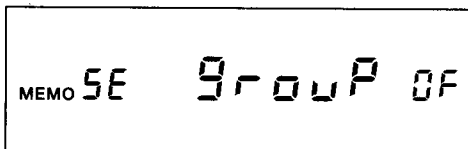

MEMO SE group OF

4. Press the **UP/DOWN** keys to select “On” or “OF.”

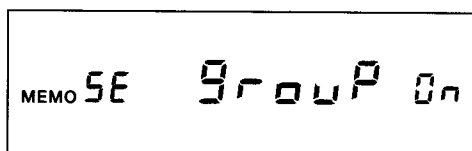

MEMO SE group On

5. Press the **FUNC** key to confirm the selection and exit from the **SET** mode.



*Note: If there is no key entry within 5 seconds after **FUNC** appears, the function will be canceled.*



## CTCSS Tone Setting

(EJ-34U CTCSS Tone Encoder must be installed. Standard for DX-77T, optional for DX-77E.)

### Description

The **CTCSS** tone, sometimes called **PL** tone, is a sub-audible tone superimposed on your voice so that the receiving party can segregate your signal from others on the same frequency. It is often used for repeater uplink. There are 50 types of tones with the EJ-34U. The tone setting is activated only in FM mode.

### Procedure

1. Press the **FUNC** key.
2. Press again and hold the **FUNC** key down longer than 2 seconds to access the **SET** mode.
3. Press the **NB** key and the tone frequency appears on the LCD.
4. Use the **UP/DOWN** keys to set the desired tone frequency.

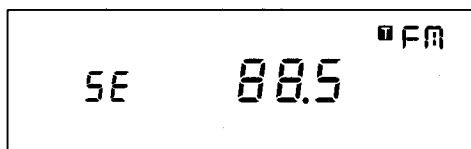

5. Press the **FUNC** key to confirm the selection and exit from the **SET** mode.

*Note:*

- If there is no key entry within 5 seconds after **FUNC** appears, the function will be canceled.
- In FM mode, press the **FUNC** key followed by the **H/L** key to turn on/off the tone.

## Electronic Keyer Setting

(EJ-33U Electronic Keyer Unit must be installed. Standard for DX-77T, optional for DX-77E.)

### Description

The EJ-33U offers automatic dot and dash keying functions for speedy **CW** transmission. When the keyer unit is installed but is turned **OFF**, the unit works in semi-automatic mode that can key only dots, while dashes should be emitted manually, i.e. the dash contact works as straight key. When the keyer unit is turned **ON**, both dots and dashes are keyed automatically by manipulating each respective contacts, in a range of 6 to 50 wpm.

### Procedure

1. Press the **FUNC** key.
2. Press again and hold the **FUNC** key down longer than 2 seconds to access the **SET** mode.
3. Press the **TUNE** key repeatedly until **ELE** appears on the LCD.

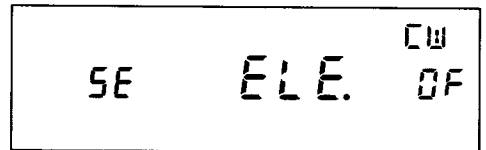

4. Use the **UP/DOWN** keys to turn **ON/OFF** the keyer.
5. Press the **TUNE** key again and **SPE** appears on the LCD, with the number on the right of **SPE** showing the speed of the keyer in wpm (words per minute).

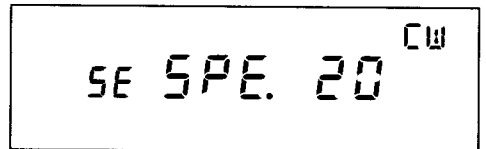

6. Use the **UP/DOWN** keys to set the keyer speed.
7. Press the **FUNC** key to confirm the selection and exit from the **SET** mode.

*Note: If there is no key entry within 5 seconds after **FUNC** appears, the function will be canceled.*

---

## Cable Cloning

---

### Description

Cloning with a cable is possible with the DX-77. Memories and other set-up items in one DX-77 (master) can be transferred to another DX-77 (slave). Prepare a three conductor cable with 3.5mm diameter stereo plugs on both ends (the cloning cable).

### Procedure

- 1.** Connect the master and slave radios using the cloning cable, through the remote jack on the rear of the radios.
- 2.** On both the master and slave radios, press and hold the Dial Lock key and turn the power ON. (The displays show "CLonE" on both radios.)
- 3.** Press the PTT key on the master radio. The display on the master counts "P"-numbers showing data transfer. (The data transfer rate is fixed at 9600 bps).
- 4.** Upon successful transfer, the master shows "Good" and the slave returns to normal operation mode. If an error occurs, the display shows "Err\*" (\*=numbers 1 to 6) on the master radio; in this case start over from the beginning.
- 5.** Turn the power off to exit the clone mode.

# Chapter 7 Maintenance

## 7.1 ADJUSTMENT

### Introduction

This transceiver has been strictly tested and completely adjusted at the factory prior to shipment. When adjusting, therefore, be careful not to touch the non-user-servisable components such as the preset resistors/pots, coils, and trimmers inside.

### Adjustment Item List

Remove the covers and perform the following:

- Adjust sidetone volume.
- Adjust microphone gain.
- Select 100 W or 50 W output.
- Aligning with standard frequency.

### Removing the Covers

Remove the covers as shown below.

- Top cover

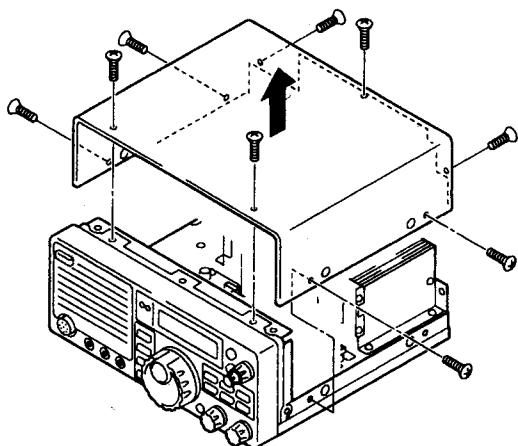

- Bottom cover

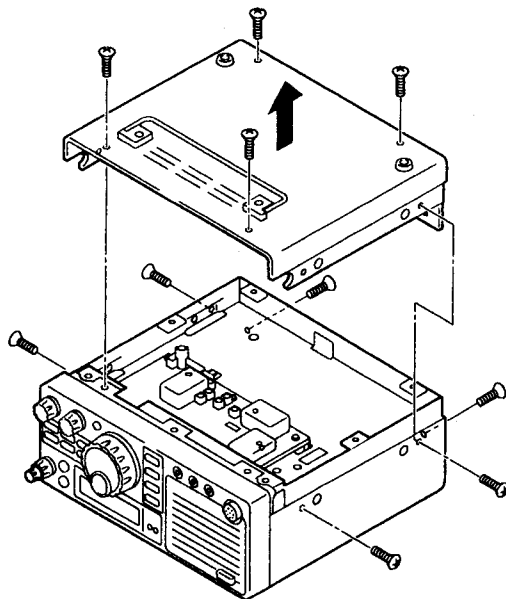

**Warning:** Be sure to turn the **POWER** switch off and unplug the DC cable before removing the covers.

## Procedure

### Adjusting microphone gain

- Adjust such that the brightness of the **TX LED** changes according to transmit audio intensity.
- Turn clockwise to increase, and turn counterclockwise to decrease.

Top view →

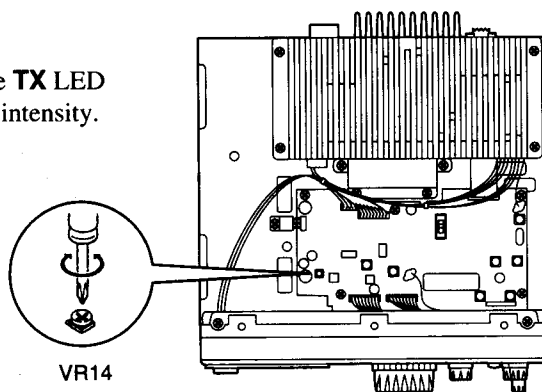

VR14

### Selecting 100 W or 50 W output

Top view →

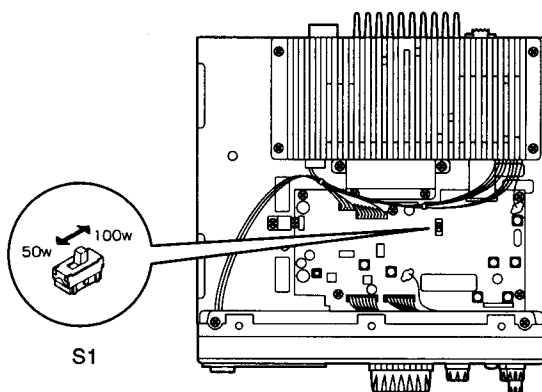

S1

### Adjusting beep and sidetone volume

- Turn clockwise to increase, and turn counterclockwise to decrease.

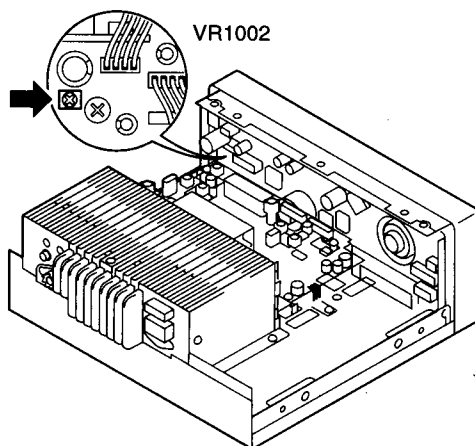

VR1002

## Aligning with standard frequency

1. Remove the bottom cover to access the PLL unit.
2. Access the **SET** mode and set the **CW** offset to 800 Hz (see page 6-4). Then set transmission to off (see page 6-9).
3. Select the **CWU** or **CWL** mode. Then let DX-77 display frequency of "5.0000," "10.0000," or "15.0000" to tune in a Standard Time Frequency station such as WWV and WWVH on 5, 10, or 15 MHz.
4. When the WWV signal is received, you will hear an approximate 800 Hz tone. (If not received, try receiving the WWV or other standard signal on another frequency)
5. Key down in the **CW** mode, and you will hear a 800 Hz sidetone, or the tone you have set in the set-mode.
6. The WWV tone will mix with the sidetone to produce a beat sound.
7. Adjust the PLL unit (TC701) to achieve a zero-beat sound.

Bottom view →

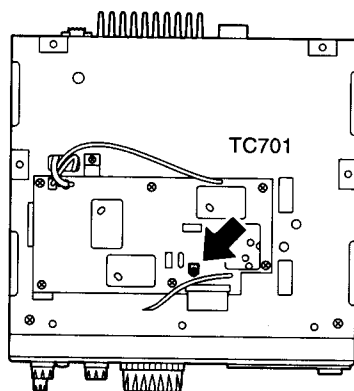

## 7.2 RESET

### Procedure

#### Resetting all memory channels and SET mode settings

- While pressing the **FUNC** key, turn the power on.

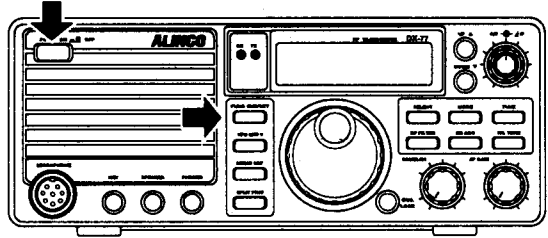

#### Resetting all memory channels

- While pressing the **MEMO** key, turn the power on.

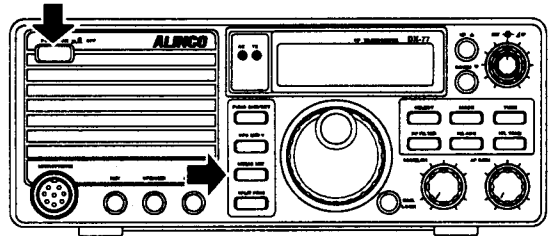

#### Resetting the VFO's

- While pressing the **VFO** key, turn the power on.

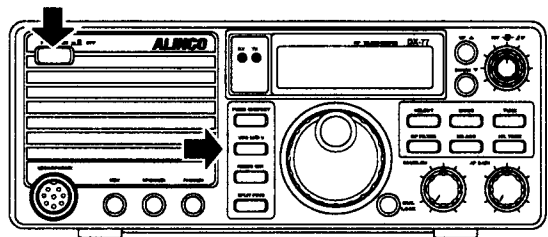

#### Restoring the SET mode settings to factory defaults

- While pressing the **SPLIT** key, turn the power on.

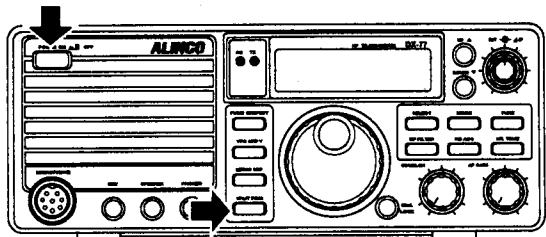

## 7.3 CLEANING

---

- Use a dry, silicone or soft cloth to clean the control panel and case.



**Notes:** ● *When cleaning, do not use thinner, benzine, alcohol, or any solvent that might deform or discolor the transceiver.*

- *If any part of the transceiver is excessively dirty, use a water-diluted neutral detergent to clean.*



## 7.4 TROUBLESHOOTING

If a problem should occur, first try the troubleshooting procedure given below. If the problem persists, contact your nearest ALINCO dealer or ALINCO office as appears on back cover of this manual.

Symptom	Possible Cause	Remedy
Power does not come on.	<ol style="list-style-type: none"> <li>1. DC power cable is incorrectly connected.</li> <li>2. Fuse is blown.</li> <li>3. Plug polarity is wrong.</li> <li>4. Power switch of DC regulated power supply is off.</li> <li>5. Voltage from the power supply is insufficient.</li> </ol>	<ol style="list-style-type: none"> <li>1. Correctly connect cable.</li> <li>2. Replace fuse. (<i>page 1-5</i>)</li> <li>3. Correct polarity and replace fuse.</li> <li>4. Turn power switch on.</li> <li>5. Supply a regulated 13.8 V DC <math>\pm</math> 15%</li> </ol>
Abnormal LCD display.	<ol style="list-style-type: none"> <li>1. Power supply voltage is low. To transmit at 100W output, the power supply must be capable of supplying 20 Amps continuously at 13.8 V DC</li> </ol>	<ol style="list-style-type: none"> <li>1. ● Check that DC regulated power supply is used.</li> <li>● Adjust the operating voltage within a range of 13.8 V DC <math>\pm</math> 15% (11.7 to 15.8 V DC).</li> <li>● To transmit at 100W output, the power supply must be capable of supplying 20 Amps continuously at 13.8 V DC.</li> </ol>
No sound from speaker.	<ol style="list-style-type: none"> <li>1. <b>AF</b> control knob is turned fully counterclockwise.</li> <li>2. <b>PTT</b> key of microphone is on.</li> <li>3. Telegraph key is in transmission.</li> <li>4. External speaker cable is short-circuited or damaged.</li> <li>5. Headphones or earphone is plugged into the speaker jack.</li> <li>6. Squelch level is set too high.</li> </ol>	<ol style="list-style-type: none"> <li>1. Rotate <b>AF</b> control knob to adjust volume. (<i>page 2-1</i>)</li> <li>2. Release <b>PTT</b> key. (<i>page 2-8</i>)</li> <li>3. Stop keying with telegraph key. Also check that cable plug is not short-circuited.</li> <li>4. Check cable.</li> <li>5. Unplug headphones or earphone. (<i>page 1-11</i>)</li> <li>6. Turn <b>SQL</b> control knob counterclockwise to unmute squelch. (<i>page 2-1</i>)</li> </ol>
Only strong signals are received.	<ol style="list-style-type: none"> <li>1. Squelch is muted.</li> <li>2. <b>ATT</b> is on.</li> <li>3. Defective antenna or short-circuited or damaged coaxial cable.</li> <li>4. Antenna is not suitable for receive band.</li> </ol>	<ol style="list-style-type: none"> <li>1. Turn <b>SQL</b> control knob counterclockwise. (<i>page 2-1</i>)</li> <li>2. Press <b>RF</b> key to turn <b>ATT</b> off. (<i>page 2-6</i>)</li> <li>3. Check antenna, cable, and especially UHF plug. (<i>page 1-6</i>)</li> <li>4. Connect correct antenna for receive band.</li> </ol>
Received signal is not demodulated.	<ol style="list-style-type: none"> <li>1. Wrong mode is set. (If SSB, also check LSB and USB)</li> <li>2. Wrong passband is set.</li> </ol>	<ol style="list-style-type: none"> <li>1. Press the mode key. (<i>page 2-2</i>)</li> <li>2. ● Turn <math>\Delta</math>IF control knob to a position where proper audio can be heard. (<i>page 5-1</i>)</li> <li>● Select proper filter. (<i>page 5-2</i>)</li> </ol>

Symptom	Possible Cause	Remedy
No frequency change when rotating the main tuning dial	1. Dial is locked.	1. Press <b>DIAL LOCK</b> key to free dial. (page 5-6)
Band scan will not start.	1. ▼ displayed somewhere in the LCD.	1. Press <b>SELECT</b> repeatedly until ▼ disappears. (page 4-4)
Cannot access <b>MEMORY</b> mode.	1. Memory channel is unprogrammed.	1. Program memory channel. (pages 3-3~3-6)
Memory scan will not start.	1. Memory channel is unprogrammed.	1. Program memory channel. (pages 3-3~3-6)
Memory channel cannot be programmed.	1. Memory channel is protected.	1. Turn off memory access protection (page 6-14).
Memory frequency cannot be changed.	1. Memory frequency overwrite protection is activated.	1. Turn off memory overwrite protection (page 6-13).
No transmission or low output power	1. Microphone or telegraph key connection is disconnected or poorly connected. 2. Antenna connection is poor or wrong. 3. Antenna matching is improper.  4. Microphone output level is low. 5. Transmission is inhibited ( <b>PTT</b> key is locked.) 6. Transmission is made outside the amateur band. 7. Power supply is insufficient in capacity.	1. Connect microphone or key correctly. (pages 1-11, 1-4)  2. Check antenna connection. (page 1-6) 3. Correct antenna matching. Connect correct antenna for operating bands. 4. Increase microphone gain. (page 7-2) 5. Unlock <b>PTT</b> key in <b>SET</b> mode. (page 6-9) 6. Select correct frequency and amateur band. (page 2-3) 7. Use a regulated 13.8 V DC power supply with a capacity of 20 Amps continuous duty. The cable for the power supply should be kept as short as possible, and away from co-ax if possible.
Reception and transmission are normal, but communication is impossible.	1. <b>SPLIT</b> function is on. 2. <b>RIT</b> function is on. 3. (For CW) Carrier is being received on the wrong side.	1. Turn this function off. (page 2-23) 2. Turn this function off. (page 2-7) 3. Tune in the correct frequency. (page 2-19)

---

Symptom	Possible Cause	Remedy
Linear amplifier does not activate.	<ol style="list-style-type: none"><li data-bbox="400 344 770 382">1. ALC is set to wrong level.</li><li data-bbox="400 401 770 510">2. Connection between DX-77 and the Linear-amplifier is poor.</li></ol>	<ol style="list-style-type: none"><li data-bbox="774 344 1174 401">1. Adjust ALC level on your Linear-amp.</li><li data-bbox="774 401 1174 643">2. Check that relay-cable, ALC-cable, co-ax cable are all connected properly between DX-77 and the Linear-amp. Also check that DX-77's HF antenna terminal is connected with the HF Linear-amp. (<i>page 1-12</i>)</li></ol>

# OPTIONS

- EDX-1 manual antenna tuner

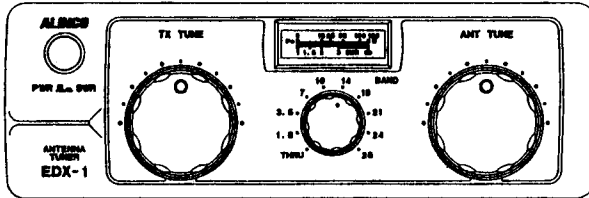

- EDX-2 automatic antenna tuner

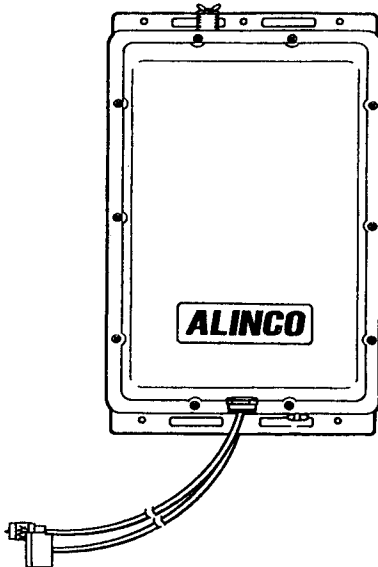

- EJ-33U Electronic keyer unit  
(comes standard with DX-77T)
- EJ-34U CTCSS tone encoder  
(comes standard with DX-77T)
- DJ-35U CW I.F. Crystal Filter (500Hz (-6dB), 1.35kHz (-60dB))  
(comes standard with DX-77T)

# EXTERNAL ANTENNA TUNERS AVAILABLE

## ALINCO EDX-1

### ■ Connection Example

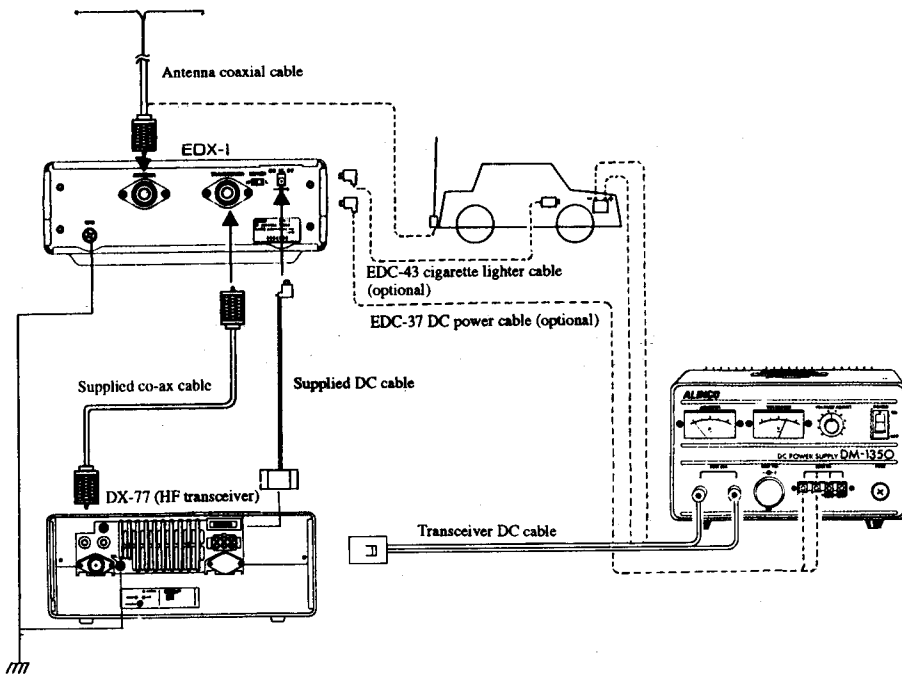

## ALINCO EDX-2

### ■ Connection Example

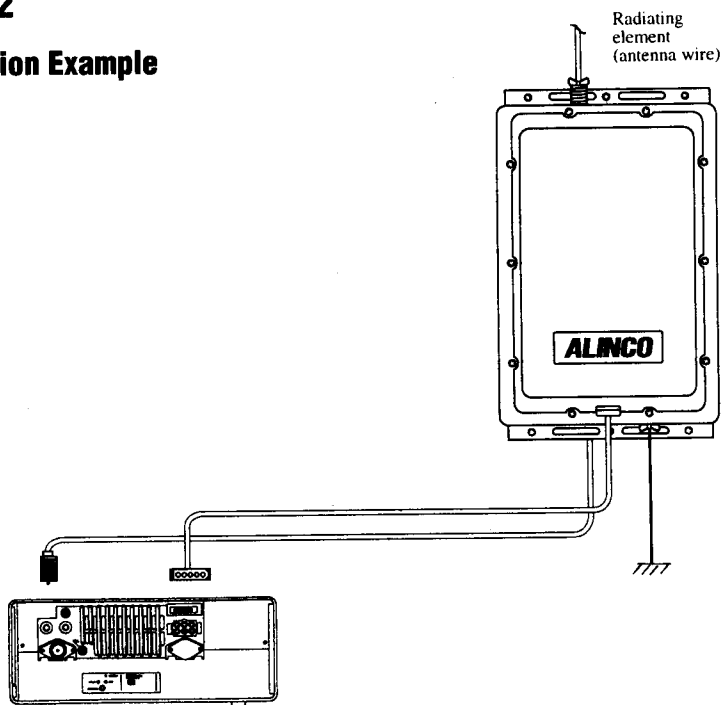

## KENWOOD AT-300

### ■ Connection Example

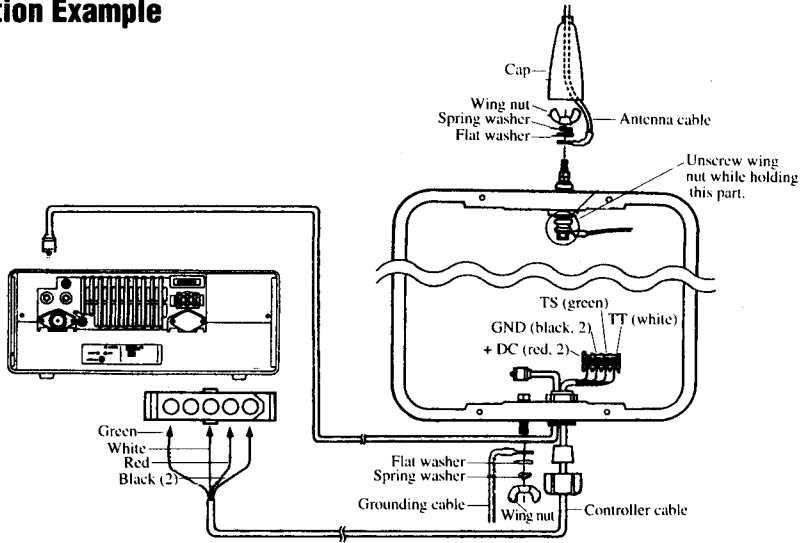

## ICOM AH-3

### ■ Connection Example

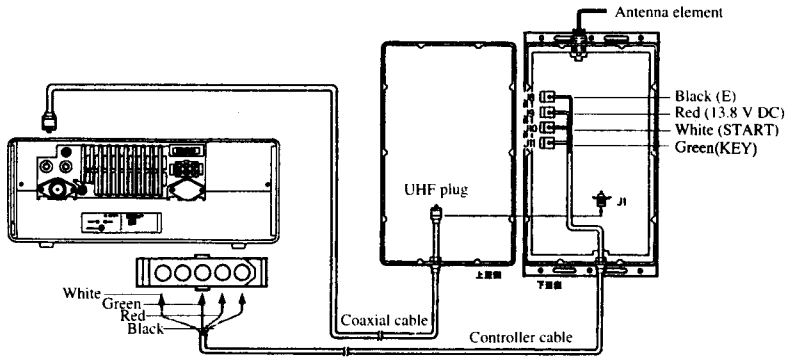

**Notes:** ● For details on how to connect an antenna tuner, see the instruction manual provided with it.

# INSTALLING THE OPTIONS

## Installing the options

- EJ-33U
- EJ-34U

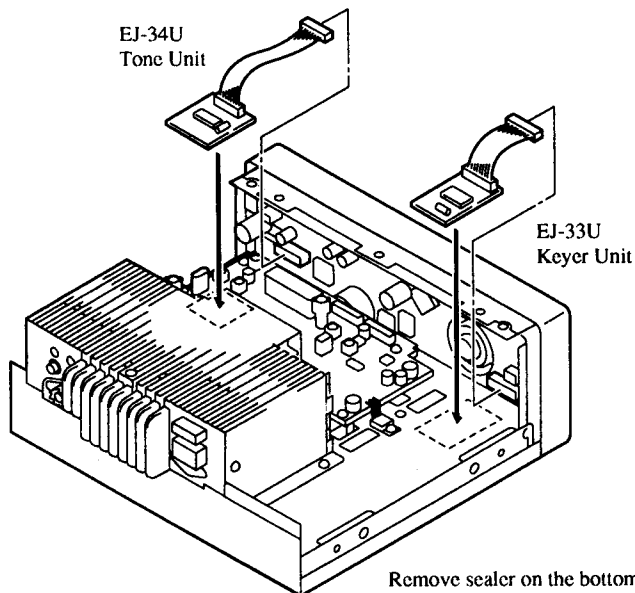

Remove sealer on the bottom of the modules and adhere to designated place.

## ■ EJ-35U

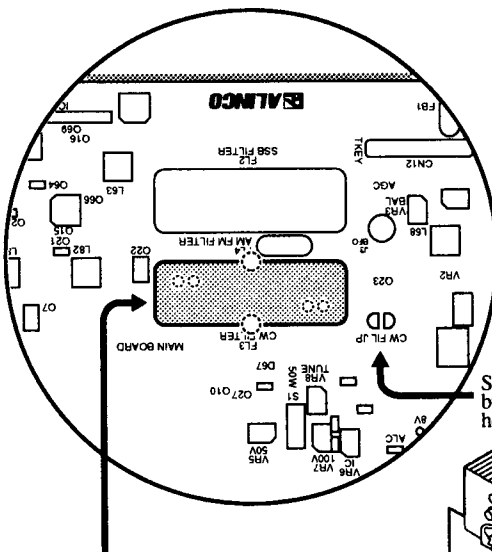

solder the pads on reverse side of PC board (6 locations)

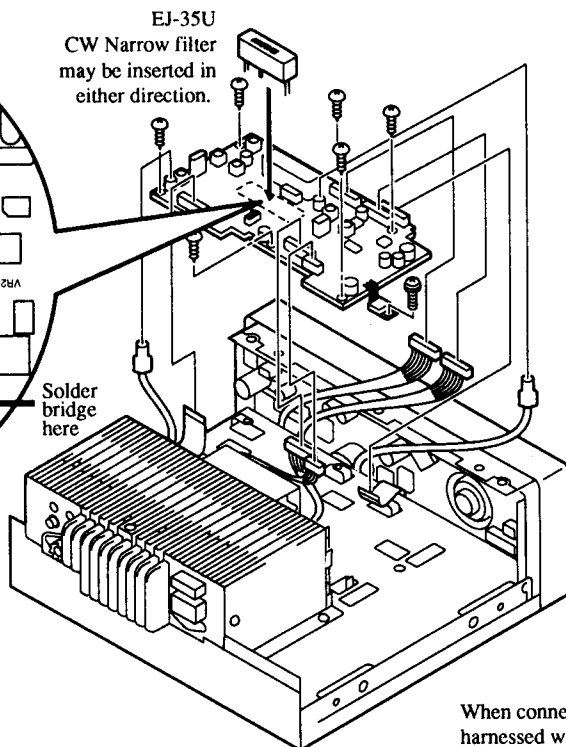

EJ-35U CW Narrow filter may be inserted in either direction.

Solder bridge here

When connecting, make sure that harnessed wires do not cross.

# SPECIFICATIONS

## ■ General

Operating mode		J3E (LSB, USB), A3E (AM), A1A (CW), F3E (FM)
Number of memory channels		100
Antenna impedance		50
Power requirement		13.8 VDC $\pm$ 15% (11.7 to 15.8V)
Ground method		Negative ground
Current drain	Receive	1.1A max.
	Transmit	20A max.
Operating temperature		-10°C to 60°C
Frequency stability		$\pm$ 10 ppm (-10°C to 50°C)
Dimensions		246(W) $\times$ 94(H) $\times$ 228(D) mm (247 $\times$ 100 $\times$ 268 mm for projection included)
Weight		Approx. 3.8kg

## ■ Transmitter

Transmit frequency coverage	160m band	1.8000 to 1.9999 MHz
	80m band	3.5000 to 3.9999 MHz
	40m band	7.0000 to 7.2999 MHz
	30m band	10.1000 to 10.1499 MHz
	20m band	14.0000 to 14.3499 MHz
	17m band	18.0680 to 18.1679 MHz
	15m band	21.0000 to 21.4499 MHz
	12m band	24.8900 to 24.9899 MHz
	10m band	28.0000 to 29.6999 MHz
Power output	SSB, CW, FM	100W (high)      Approx. 10W (low)
	AM	40W (high)      Approx. 4W (low)
Spurious emission		Less than -50dB (-45dB in 30m band)
Modulation system	SSB	Balanced modulation
	AM	Low power modulation
	FM	Reactance modulation
Carrier suppression		More than 40dB
Sideband suppression		More than 50dB (at 1 kHz)
Maximum FM deviation		$\pm$ 2.5 kHz
Microphone impedance		2k $\Omega$



### ■ General

Receiver circuitry		Double conversion superheterodyne	
Receiver frequency range		0.5 MHz to 30.0000 MHz	
Sensitivity	SSB, CW, FM	0.5 to 1.8 MHz	0dB $\mu$ V (1 $\mu$ V)
		1.8 to 30 MHz	-12dB $\mu$ V (0.25 $\mu$ V)
	AM (1 kHz 30% mod.)	0.5 to 1.8 MHz	(20dB $\mu$ V (10 $\mu$ V)
		1.8 to 30 MHz	(6dB $\mu$ V (2 $\mu$ V)
	FM (12dB SINAD)	-6dB $\mu$ V (0.5 $\mu$ V)	
Selectivity	SSB, CW, AM (narrow)		2.7 kHz (-6dB), 4.7 kHz (-60dB)
	AM, FM		8 kHz (-6dB), 30 kHz (-50dB)
Spurious and image rejection ratio		More than 70dB	
Audio output power		More than 2.0W (8 $\Omega$ , 10%THD)	
RIT range		$\pm$ 1.0 kHz	

*Note: Specifications are subject to change without notice.*

# INDEX

<u>key word</u>	<u>page</u>	<u>key word</u>	<u>page</u>
ΔIF.....	1-8, 5-1	general coverage.....	2-15
access protection.....	6-14	group memory scan.....	6-16
accessories.....	1-2, 1-12. see also OPTIONS	H/L.....	1-9, 2-9
AF Gain.....	see VOLUME	I.F. shift.....	5-1
AGC.....	2-6	installing options.....	Appendix-4/5
ALC.....	1-12	KEY.....	1-4, 1-10, 6-18
AM.....	2-14	keyer (delay).....	6-5
ANTENNA.....	1-3, 1-6, 1-12, Appendix-2	lamp.....	6-2
antenna tuner.....	1-3, 1-6, Appendix-1~3	LCD.....	1-14, 6-6
attenuator.....	2-6, 2-12	LOW.....	1-9, 1-15, 2-9
beep.....	6-7	M→V.....	3-9
BFO.....	5-3	MEMO.....	1-10, 3-1~3-9, 6-13, 6-14
break-in.....	6-5, 2-21	memory.....	see MEMO
BUSY.....	1-15	microphone.....	1-10, 1-13, 2-2, 7-2,
cable.....	1-7	MODE.....	1-9, 1-16, 2-2
cable cloning.....	6-19	modulation.....	see MODE
CHK/SET (FUNC).....	1-9, 1-16	MW.....	3-3, 3-4, 3-5
cleaning.....	7-5	NAR.....	1-14, see also FILTER
cloning.....	6-19	NB.....	1-9, 5-3
compressor.....	6-8	noise blanker.....	see NB
CTCSS.....	see TONE	OFF band.....	2-9
CW.....	2-18, 2-20, 5-3, see also KEY	options.....	Appendix-1/4/5
CW filter.....	5-2, Appendix-5	overwrite protection.....	6-13
D-LOCK.....	see Dial Lock	packet.....	2-22
dial lock.....	1-9	phones.....	1-4, 1-10
DOWN.....	1-8, 2-3	PLL.....	7-3
EDX-1.....	Appendix-2	POWER.....	1-5, 1-7, 1-8, 2-1, 7-2
EDX-2.....	1-6, Appendix-2	preamplifier.....	2-6, 2-13
EJ-33U.....	1-4, 6-18, Appendix-4	PRIO.....	4-2, 4-6
EJ-34U.....	6-17, Appendix-4	priority.....	see PRIO
EJ-35U.....	5-2, Appendix-5	PTT.....	1-13, 2-10, 6-9
electronic keyer.....	see EJ-33U	QSK.....	see BREAK-IN
FAX.....	2-22	quick offset.....	3-5, 2-24
FILTER.....	5-2		
FM.....	2-16, 2-17		
frequency.....	2-1, 7-3		
FSK.....	see PACKET		
FUNC.....	1-8, 1-16		
function.....	see FUNC		
fuse.....	1-2, 1-5		

---- to be continued

---

<b>key word</b>	<b>page</b>
relay .....	1-12
remote.....	1-12
Repeater.....	2-17
resetting .....	7-4
RF.....	1-9, 2-6, 2-12, 2-13
RIT .....	1-8, 2-7
RTTY.....	2-22
RX LED (lamp) .....	1-8, 2-1
S-meter .....	1-15
Scan (band) .....	4-4, 4-1
Scan (delay).....	4-3, 6-15
Scan (group).....	6-16
Scan (memory).....	4-5, 4-2
scanning.....	4-1-4-6
SELECT.....	1-9, 1-16, 2-3
sidetone .....	2-19, 6-4, 7-2
speaker.....	1-4, 1-10
specifications.....	Appendix-6-7
speech compressor .....	6-8
speed, keyer.....	6-18
SPLIT .....	1-10, 2-12, 3-5, 3-6
squelch.....	1-9, 2-1
SSB.....	2-10, 2-12
SSTV .....	2-22
standard frequency .....	7-3
step .....	6-10, 6-11, 6-12
TONE .....	6-17
troubleshooting.....	7-8-7-10
TUNE.....	1-9, 1-15, 1-16, Appendix-2/3
TX LED (lamp).....	1-8, 2-8
UP.....	1-8, 2-3
USB/LSB.....	6-3, 1-9, 2-10
VFO.....	1-10, 2-4
VFO A=B.....	5-5
volume (AF gain).....	1-9, 2-1
WWV .....	7-3

# **ALINCO, INC.**

Head office: "TWIN 21" MID Tower Building 25F  
1-61, 2-Chome, Shiromi, Chuo-ku, Osaka 540-8580 Japan  
Phone: 06-6946-8150 Fax: 06-6946-8175 Telex: 63086  
E-mail: 101243.1446@compuserve.com  
U.S.A.: 438 Amapola Ave., Suite 130, Torrance, CA 90501-6201 U.S.A.  
Phone: 310-618-8616 Fax: 310-618-8758  
<http://www.alinco.com/>  
Germany: Eschborner Landstrasse 55, 60489 Frankfurt am Main, Germany  
Phone: 069-786018 Fax: 069-789-60766